

Radio-Electronics[®]

A
GERNSBACK
PUBLICATION

**How they work—
New solid-state
TV rotators**

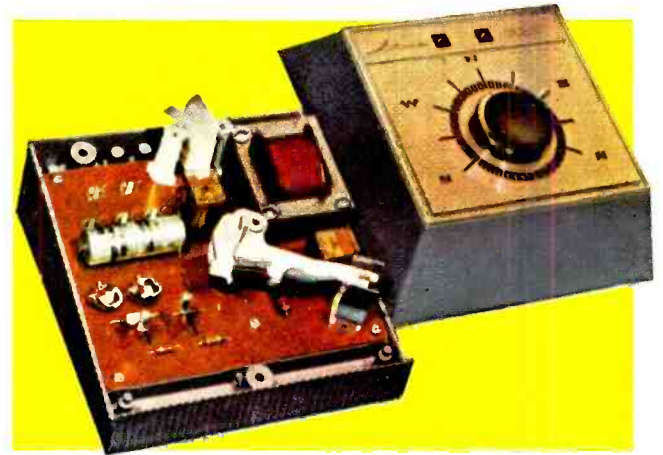

**Experimenters
MOSFET circuits
you can build**

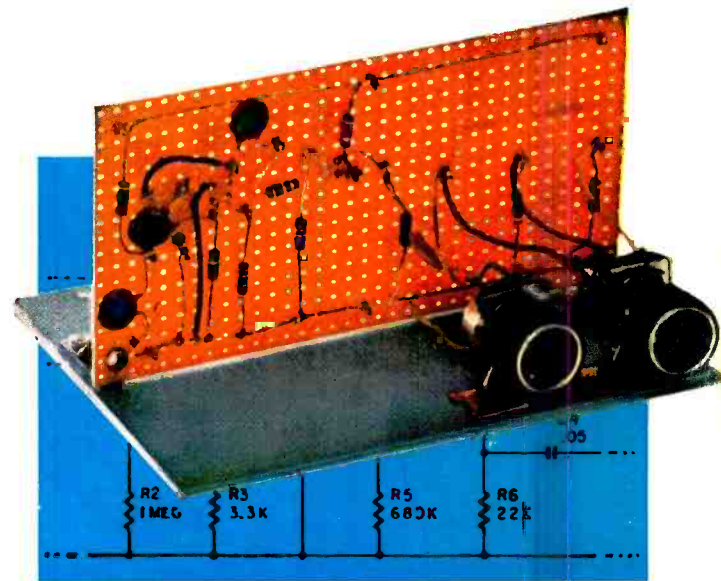

**New in stereo
Cassettes '70**



Dazzle your friends with lightworks.

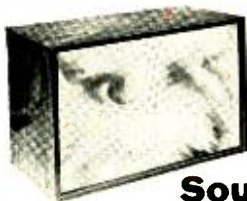

Sound n' Color®

The new dimension to music pleasure. EICO All Electronic Solid-State Audio-Color Organs transform sound waves into moving synchronized color images. Connect easily to speaker leads of hi-fi or radio. From \$29.95.



Translators

The electronics you need to create audio-stimulated light displays to your own imagination. Actuates: Light Display Units, Strobe Lites, any lamp configuration (Xmas trees, patio lights, etc.). From \$24.95 kit, \$39.95 wired.



Strobe Lites

High-intensity bursts of white light from Xenon tube flash in cadence with each beat of audio. From \$24.95 kit, \$39.95 wired.

Build the Stereo Kits praised by experts.

All amplifier power ratings according to IHF standards. Cortina® designed and manufactured in U.S.A. and guaranteed by EICO.



70-Watt AM/FM Stereo Receiver including cabinet. Cortina 3770, \$189.95 kit, \$279.95 wired.

70-Watt FM Stereo Receiver including cabinet. Cortina 3570, \$169.95 kit, \$259.95 wired.



150-Watt Silicon Solid-State Stereo Amplifier, including cabinet. For the audio perfectionist. Cortina 3150, \$149.95 kit, \$225 wired.

70-Watt Silicon Solid-State Stereo Amplifier, including cabinet. Cortina 3070, \$99.95 kit, \$139.95 wired.

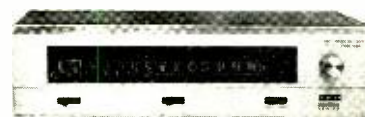

FM Stereo Tuner including cabinet. Cortina 3200, \$99.95 kit, \$139.95 wired.



EC-1100
FM WIRELESS MIKE \$9.95

Build for fun and use with Eicocraft jiffy project kits.

The newest excitement in kits. 100% solid-state and professional. Expandable, interconnectable. Excellent as introductions to electronics. No technical experience needed. Finest parts, pre-drilled etched printed circuit boards, step-by-step instructions. 36 kits to select from, \$2.50 to \$9.95. Just released: EC-2600 "Super Snoop" \$8.95; EC-2700 Police & Fire Converter



(to band) \$7.95; EC-2800 Aircraft Converter \$7.95; EC-2900 Police & Fire Converter (hi band) \$7.95; EC-3100 2-Station Intercom (with cases) \$10.95; EC-3200 "Do-It-Yourself" PC Etching Kit \$4.95; EC-2300 Audio Preamplifier \$8.95; EC-2400 Bullhorn \$8.95; EC-2500 Fuzzbox \$8.95.



EC-1900 TREASURE FINDER \$9.95

Shape up your own car/boat with EICO Engine Analyzer

For all 6V/12V systems; 4, 6, 8-cyl. engines. Now you can keep your car or boat engine in tip-top shape with this solid-state, portable, self-powered universal engine analyzer.

Completely tests your total ignition/electrical system. Complete with comprehensive Tune-up & Trouble-shooting Manual. EICO 888, \$49.95 kit, \$69.95 wired.



The first and only solid-state test equipment guaranteed for 5 yrs.

Only EICO brings you laboratory precision and long life at lowest cost.

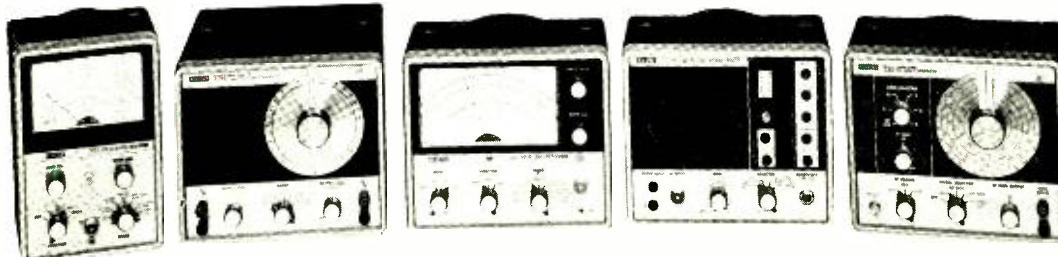

EICO 240 Solid-State FET-TVOM \$49.95 kit, \$69.95 wired

EICO 379 Solid-State Sine/Square Wave Generator \$54.95 kit, \$74.95 wired

EICO 242 Solid-State Deluxe FET-TVOM \$59.95 kit, \$79.95 wired.

EICO 150 Solid-State Signal Tracer \$49.95 kit, \$69.95 wired

EICO 330 Solid-State RF Signal Generator \$59.95 kit, \$79.95 wired

You save up to 50% with EICO Kits. Since 1945, Best Buys in Electronics. Over 3 Million EICO Instruments Now in Use.

FREE 1969 CATALOG Send me FREE catalog describing the full EICO line of 200 best buys, and name of nearest dealer.



EICO Electronic Instrument Co., Inc.
283 Malta Street, Brooklyn, N.Y. 11207
Available In Canada

Name _____

Address _____

City _____

State _____

Zip _____

Special introductory offer to new members of the ELECTRONICS AND CONTROL ENGINEERS' BOOK CLUB



For trial membership take

ANY ONE
for only \$**1.00**
Values up to \$12.50

Choose bonus from
Library Group A

#A850 MATHEMATICS FOR ELECTRONICS WITH APPLICATIONS by H. M. Nodelman and F. W. Smith. Pub. price, \$8.00. Club price, \$6.80

#A896 BASIC PULSE CIRCUITS by R. Blitzer. Pub. price, \$8.50. Club price, \$7.25

#A530 PROJECT ENGINEERING by V. Hajek. Pub. price, \$9.75. Club price, \$8.30

#A355 FIELD-EFFECT TRANSISTORS by L. J. Sevin. Pub. price, \$10.00. Club price, \$8.50

#A475 MOSFET IN CIRCUIT DESIGN by R. H. Crawford. Pub. price, \$10.00. Club price, \$8.50

#A142 TUNNEL-DIODE AND SEMI-CONDUCTOR CIRCUITS by J. M. Carroll. Pub. price, \$11.00. Club price, \$9.35

#A509 MATHEMATICS MANUAL by F. S. Merritt. Pub. price, \$11.95. Club price, \$10.15

#A955 ELECTRONIC TESTING by L. L. Farkas. Pub. price, \$12.00. Club price, \$10.25

#A144 DESIGN MANUAL FOR TRANSISTOR CIRCUITS by J. M. Carroll. Pub. price, \$12.50. Club price, \$10.65

For trial membership take

ANY ONE
for only \$**2.00**
Values up to \$16.50

Choose bonus from
Library Group B

#B978 TRANSFORMERS FOR ELECTRONIC CIRCUITS by N. R. Grossner. Pub. price, \$14.00. Club price, \$11.90

#B905 INTRODUCTION TO RADAR SYSTEMS by M. I. Skolnik. Pub. price, \$14.50. Club price, \$12.35

#B677 DATA TRANSMISSION by W. R. Bennett. Pub. price, \$14.50. Club price, \$12.35

#B270 MICROWAVE MEASUREMENTS by E. L. Ginzton. Pub. price, \$16.50. Club price, \$14.05

#B310 AUTOMATIC FEEDBACK CONTROL SYSTEMS by J. G. Truxal. Pub. price, \$16.50. Club price, \$14.05

#B690 MODERN OPTICAL ENGINEERING by W. J. Smith. Pub. price, \$16.00. Club price, \$13.60

#737 TRANSISTOR CIRCUIT DESIGN by Texas Instruments, Inc. Staff. Pub. price, \$16.50. Club price, \$14.05

#B981 DIGITAL COMPUTER AND CONTROL ENGINEERING by R. S. Ledley. Pub. price, \$16.50. Club price, \$14.05

For trial membership take

ANY ONE
for only \$**3.00**
Values up to \$37.50

Choose bonus from
Library Group C

#C509 ELECTRONIC AND RADIO ENGINEERING by F. E. Terman. Publisher's price, \$19.50. Club price, \$16.55

#C861 FLUID AMPLIFIERS by J. M. Kirshner. Pub. price, \$17.75. Club price, \$15.10

#C381 PULSE, DIGITAL, AND SWITCHING WAVEFORMS by J. Millman and H. Taub. Pub. price, \$18.00. Club price, \$15.30

#C360 ELECTRONIC ANALOG AND HYBRID COMPUTERS by G. A. Korn and T. M. Korn. Pub. price, \$18.75. Club price, \$15.95

#C085 DIGITAL AND SAMPLED-DATA CONTROL SYSTEMS by J. T. Tou. Pub. price, \$19.75. Club price, \$16.75

#C304 HANDBOOK OF SEMICONDUCTOR ELECTRONICS 2/e by L. P. Hunter. Pub. price, \$22.50. Club price, \$19.10

#C290 ANTENNA ENGINEERING HANDBOOK by H. Jasik. Pub. price, \$27.75. Club price, \$23.50

#C371 SYSTEM ENGINEERING HANDBOOK edited by R. E. Machol. Pub. price, \$29.50. Club price, \$25.00

#C503 AMPLIFIER HANDBOOK by R. F. Shea. Pub. price, \$37.50. Club price, \$29.50

You can save time and money by using this coupon to join today

YOUR BONUS BOOK comes with your first selection

YOUR FIRST CLUB SELECTION available from any Library Group above

HERE is a professional book club designed to meet day-to-day engineering needs by providing practical books in your field on a regular basis at below publisher prices.

How the club operates: Basic to the Club's service is its publication, the *Electronics and Control Engineers' Book Club Bulletin*, which brings you news of books in your field. Sent to members without cost, it presents in detail the featured book of the month as well as many alternate selections also available at special members' prices.

When you want to examine the Club's featured book, you do nothing. It will be mailed as a regular part of your Club service. If you prefer one of the alternate selections—or if you want no book at all for that month—you let us know by returning the convenient card enclosed with each Bulletin.

◀ Circle 8 on reader service card

As a member, you agree only to take four books in two years. Considering the many essential books published in your field, there will surely be at least four that you would want to own anyway. By joining the Club, you save both money and the trouble of searching for the best books.

NEVER A MEMBERSHIP FEE

ELECTRONICS AND CONTROL ENGINEERS' BOOK CLUB
330 W. 42 St., 18th Floor, N.Y., N.Y. 10036

Please enroll me as a member of the Electronics and Control Engineers' Book Club and send me the two books indicated below. I am to receive the bonus book at the special Library Group price and my first selection at the special Club price. These books are to be shipped on approval, and I may return them both without cost or further obligation. If I decide to keep the books, I agree to purchase as few as four additional books during the next two years at special Club prices guaranteed to be about 15% under publisher prices.

Write Code No. of
bonus book
here

Write Code No. of
first selection
here

Name _____

Address _____

City _____

State _____

Zip _____

(Offer good in U.S. and Canada only.)

E 33122

TWO NEW SPEAKER SYSTEMS

NEW YORK—Two types of speaker systems were demonstrated by Jensen and Admiral here recently. Both are designed to reduce costs for stereo systems.

Jensen's approach is a single-speaker setup using "acoustic matrixing." A circuit within a bookshelf-type cabinet combines left- and right-channel signals to produce sum and difference outputs. These signals are directed to an 8-inch acoustic suspension speaker and two 5-inch speakers, one facing left and the other right.

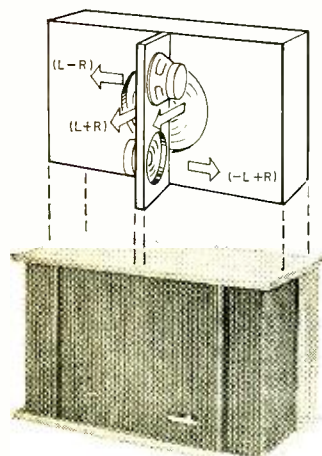

Jensen's Stereo 1

R-E editors. A-Bing the Jensen speaker with a two-speaker system, found that Jensen's new Stereo 1 produces a definite depth and spread in stereo, but concentrates all the instruments at the center.

Admiral presented more de-

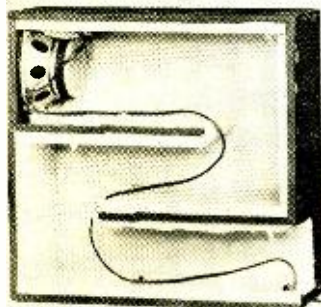

Admiral's Bull Horn

tails of its "Bull Horn" speakers announced a year ago. Essentially, these are high-compliance speakers used in vented quarter-wavelength, tunnel-reflex enclosures. The idea is to improve bass without massive woofers and powerful amplifiers. The tunnel reflex tubes (see photo) are folded to fit compact enclosures. Various sizes of the system are being used by Admiral for portable stereo phonographs and consoles.

An R-E editor, listening to a "Bull Horn" demonstration, found the system had low bass response, but noticed a "boomy" quality to audio at the low end.

IN THIS ISSUE

TV rotators have turned to solid-state control circuits. Do you know what's inside the new ones? Story starts on page 42.

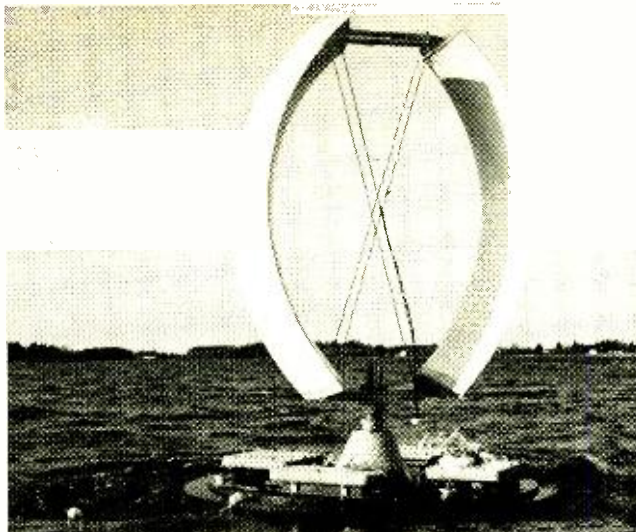

Robot sailboat afloat on the high seas. Has capability of traveling anywhere in the world, directed by radio.

16-FOOT ROBOT SAILBOAT

NEW YORK—An unmanned robot sailboat capable of moving to a fixed location at sea and "electronically tethering" itself there for a year was recently unveiled by RCA here.

The 16-foot-high vessel maintains its position by receiving signals from navigation sat-

ellites, computing where it is and where it should be, then navigating to its station. The sails are rigid, foam-filled plastic structures.

Its disc-shaped hull can carry instrumentation for oceanographic and weather research or defense operations. The SKAMP (station-keeping and mobile platform) can be recalled easily with a land-based radio signal. The Navy has expressed interest in SKAMP.

NIGHT-VISION SCOPES FOR COMMERCIAL USE

NEW YORK — Commercial versions of the military night vision scopes used in Vietnam were introduced by Raytheon Co. at an electro-optical conference recently. Suitable for law enforcement, industrial security and nature study, the MS-101-10 (photo) makes it possible to view a man under starlight conditions from about 300 yards with 4X magnification.

Not shown at the conference was a new night vision tube made by Aereojet Delft Corp. that magnifies an image from a 25-mm lens and displays it on a integral 125-mm-diameter phosphor screen. The direct-vision display tube has a cathode, focusing electrode and

(continued on page 6)

LOOKING AHEAD

by DAVID LACHENBRUCH
CONTRIBUTING EDITOR

SelectaVision and EVR

The two most influential companies in American communications-entertainment-electronics agree that the next major home electronic product will be the color video equivalent of the phonograph—the home video player. And each is pushing its own system, trying to line up allies among manufacturers first, the public later.

Shaping up is a fierce battle of the '70's between SelectaVision (SV) holographic recording and Electronic Video Recording (EVR) film system for home viewing library standards. The battle will be reminiscent, in more ways than one, of the post-World War II fight over phonograph record speeds and color TV systems. The protagonists are the veterans of those former wars—RCA Corp. and CBS Inc.

Despite the 100 per cent incompatibility of the two systems, they're both based on the same premise: That the public will want a simple-to-operate, cartridge-loading, playback-only system to play visual recordings through the antenna terminals of a color TV set—and that magnetic tape isn't the answer.

(continued on page 4)

Radio-Electronics

December 1969 • Over 60 Years of Electronics Publishing

BUILD ONE OF THESE

Transistor Curve Tracer	33 Philip Brassine
<i>Shows characteristic curves with your scope</i>		
Fuzz Box	40 Jack Jaques
<i>Make hip sounds with square waves</i>		
Automatic Enlarger Timer	50 Herbert Elkin
<i>Solid-state reliability in your darkroom</i>		

TELEVISION

In The Shop	16 Jack Darr
Solid-State TV Rotators	42 Robert F. Scott
<i>A new twist for better reception</i>		
Kwik-Fix™	57 Forest Belt
<i>6HS8 sync separator</i>		
Service Clinic	92 Jack Darr

FOR THE EXPERIMENTER

MOSFET Circuits You Can Build	61 Ray Clifton
<i>Practical circuits with this useful transistor</i>		
Five-Minute Microphone Housing	74
<i>How to turn an ashtray into a mike</i>		

ELECTRONICS TODAY

Looking Ahead	2 Dave Lachenbruch
<i>Current happenings with future overtones</i>		
Cassettes '70—New In Stereo	37 Walter Salm
<i>Latest news on the cassette scene</i>		
All About Tools	44 Tom Haskett
<i>More on screwdrivers</i>		
Careers in Electronics	69 Joseph Alderham

DEPARTMENTS

Annual Index	75	New Literature	83	Technotes	88
Correspondence	24	New Products	81	Try This One	91
New & Timely	2	Reader Service	79		

SEASON'S GREETINGS

The editors and staff of Radio-Electronics extend best wishes for the holiday season.



Photographers: put this solid-state, automatic-reset enlarger timer to work on your prints. For complete construction details . . . see page 50

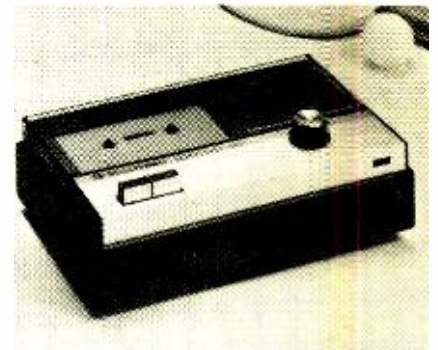

Cassette sounds are improving as new, high-quality tapes and features like this model's preamp-only output, autoload and stereo become available. see page 37

RADIO-ELECTRONICS, DECEMBER, 1969, Vol. 40, No. 12
 Published monthly by Gernsback Publications, Inc., at Ferry St., Concord, N. H. 03302
 Editorial, Advertising, and Executive offices: 200 Park Ave. S., New York, N.Y. 10003. Subscription Service: Boulder, Colo. 80302.
 Second-class postage paid at Concord, N. H. Printed in U.S.A. One-year subscription rate: U.S. and possessions, Canada, \$6.
 Pan-American countries, \$7.50. Single copies, 90¢. ©1969, by Gernsback Publications, Inc. All rights reserved.
 POSTMASTER: Notices of undelivered copies (Form 3579) to Boulder, Colo. 80302.



Radio-Electronics is indexed in Applied Science & Technology Index (formerly Industrial Arts Index)

LOOKING AHEAD

(continued from page 2)

Electronic Video Recording

CBS's EVR system is now in the advanced stages of production engineering in an industrial-educational black-and-white version, with both instruments and program cartridges promised by mid-1970. The home color version is scheduled for production the following year. Motorola has the exclusive American rights to EVR until the 1971 color system comes along, when licensing will be available to all comers. Motorola's b-w version will sell for \$795, and its color player is tentatively penciled in at 20% more, which would make it around \$950 or so.

EVR uses a cartridge-encased, sprocketless motion-picture film whose masters are recorded electronically. Prints are made by a high-speed optical exposure process. In the color version, there are two sets of frames side-by-side on b-w film, one containing a conventional optical b-w picture, the other encoded gradations of grey which are electronically decoded into the color signal within the EVR player. (A detailed description of EVR was featured in Looking Ahead in February, 1969.)

SelectaVision . . .

RCA still has an "experimental" label on its SV system, but has given some preliminary demonstrations, presumably to line up allies who might otherwise drift toward EVR. RCA says SV players and cartridges could be on the market in 1972. SV's advantages, according to RCA, are simplicity, ruggedness and low cost. The price target for the color player is \$400 at retail, with half-hour home programs to sell for less than \$10. Unlike EVR, SV is designed exclusively for home use.

SelectaVision promises to be the first product to bring the laser into the home, and is based on the new science of holography, or the recording of light interference patterns. The tape used by the SV player is low-cost uncoated vinyl on which holographic information is embossed, in much the same manner as a phonograph disc is pressed. The transport will be comparable to a standard mass-produced audio tape unit, except that it probably will have stop-motion and reverse-action capability.

Among the major advantages claimed by RCA for its new system: The tapes are virtually impervious to wear. Scratches, dust, even holes in the tape result in no visible deterioration of the picture because any segment of the frame contains all the information necessary to reproduce the entire frame. No shutter mechanism is needed, mechanical or electronic.

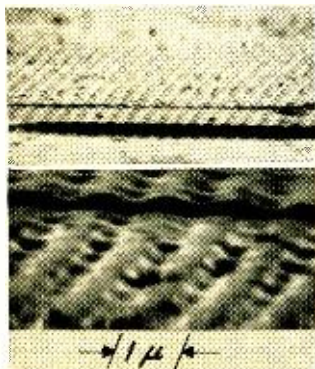

Microphoto of embossed vinyl tape with impressed holograms.

An even closer look at the hologram tape. Note size scale.

A color SV tape is produced from program material on film, video tape or live TV. The first step is to electronically print the material on b-w film, with the color information encoded as a series of vertical stripes. Then the film frames are recorded by a standard laser-beam process as holograms on a plastic tape coated with photoresist. After processing, the plastic tape, which then contains a holographic relief image, is used as a mold to make a metal tape master. Duplicate tapes are made by passing the metal tape at high speed through pressure rollers along with heated vinyl tapes, which become embossed with both the holographic and the color code information.

This printing process is considered a significant breakthrough, permitting the mass duplication of holograms and making the whole RCA system a potentially practical home viewing method. It is based on a patent recently issued to RCA, whose original application in 1964 (in England) envisioned a video disc, rather than tape.

In the home playback device, which probably will be the size of a small open-reel tape recorder, the tape is reeled past a low-powered, 2mW laser, which illuminates it and reconstructs a picture (as well as the coded color information) for

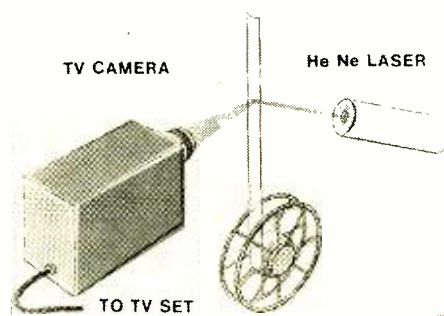

a b-w vidicon camera. An electronic decoder converts the picture and the vertical color stripes into a standard NTSC color signal, which is fed through the set's antenna terminals for viewing on an unused channel.

Tape speed and size have not been finally resolved, but in a preliminary demonstration, RCA used 1/2-inch tape, running at 7.5 ips for 30 minutes of playing time on a 6-inch reel of 2-mil tape. Resolution of a b-w picture shown on the system was about 400 lines, considered completely adequate for home viewing. The final version probably will use tape encased in a two-reel cartridge, somewhat similar to an audio cassette. The SV tape can be stopped at any individual frame for a steady still picture, or played backwards or in slow-motion without picture jitter or loss of sync. RCA's first demonstration was confined almost exclusively to b-w programming, with only a single rudimentary color picture. But engineers said perfection of the color signal was only a matter of time. No sound was on the tape; this probably will be added in the form of optical coding to be picked up by the vidicon camera, rather than a magnetic stripe.

. . . and VTR

Where does this leave the video tape recorder, previously regarded as an important future home electronic instrument? The many previous attempts to introduce magnetic-tape TV recorders for the home have failed, although the VTR has found wide acceptance in education and industry. But there's no question now that magnetic picture record-playback machines for the home have now received a major setback—at least temporarily. It may well turn out that playback-only devices will achieve popularity first, followed some years later by consumer acceptance of new, low-cost, record-and-playback TV machines—just as the phonograph came before the tape recorder in home audio systems.

(continued on Page 12)

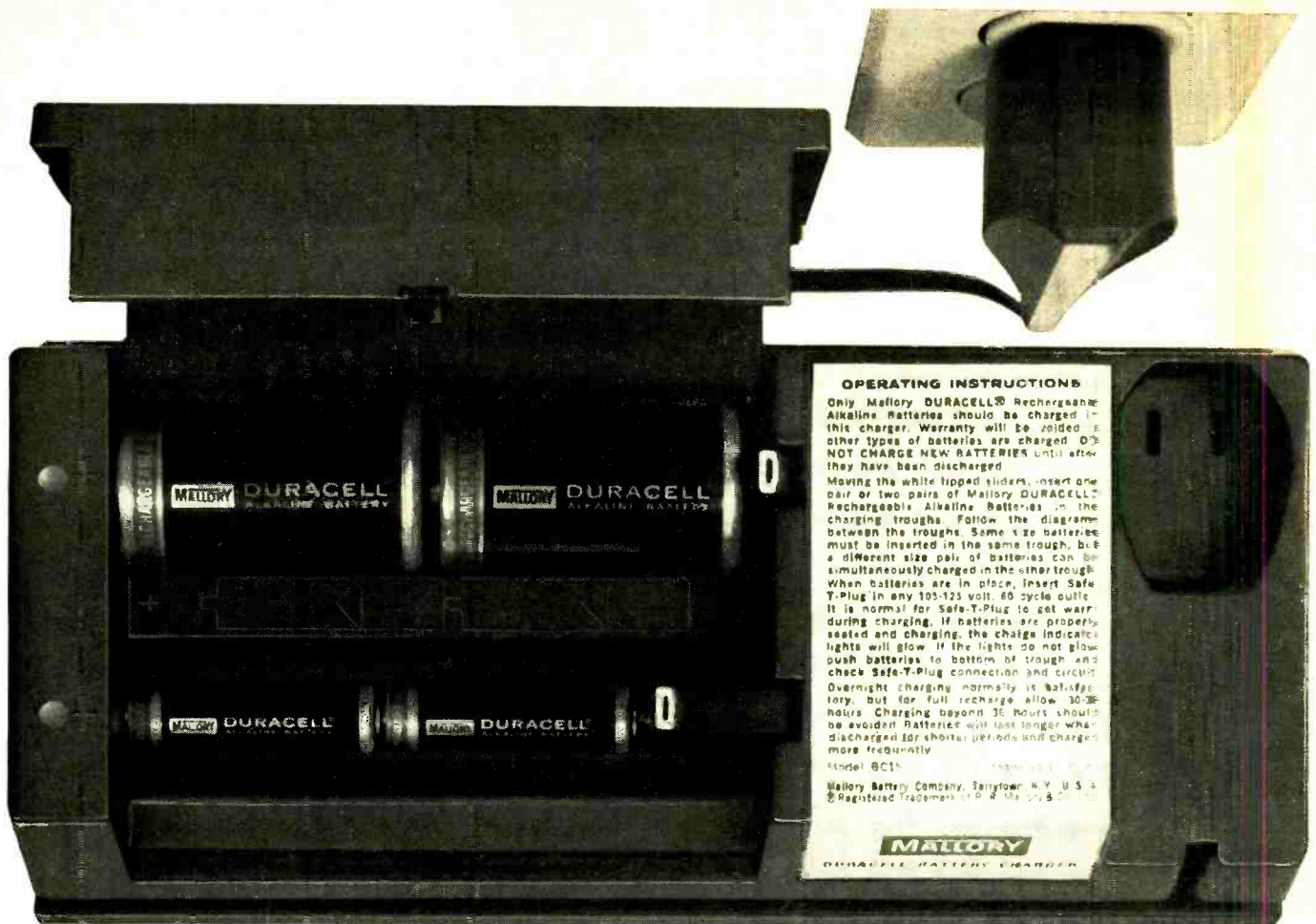

The restoration of power can be very profitable

With Mallory's new BC-15 Charger for rechargeable alkaline Duracell® batteries. It handles all rechargeable "AA", "C" and "D" Duracells. And can charge two different sizes at one time.

The BC-15 will add a lot more profit to your established Duracell business. It lists for only \$8.95. And it's a perfect follow-on sale to Duracell battery customers.

A free traffic-stopping counter display is available. It's a complete rechargeable-battery center and requires less than one square foot of

valuable counter space. This modern molded plastic display attracts high interest not only from consumers, but also technicians, repairmen . . . anyone who has worked or works with battery operated equipment or appliances.

The BC-15 is also backed up by Mallory's nationwide advertising campaign.

Contact your Mallory representative now to get information on the BC-15 Charger. See how profitable restoring power to rechargeable Duracell batteries can be.

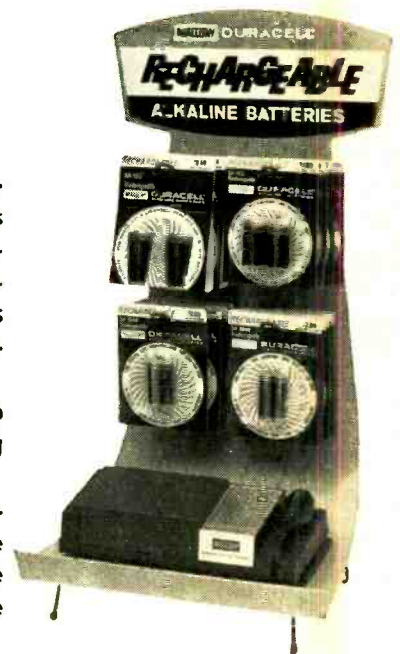

MALLORY DISTRIBUTOR PRODUCTS COMPANY

a division of P. R. MALLORY & CO. INC.
Box 1558, Indianapolis, Indiana 46206; Telephone: 317-636-5353

Batteries • Capacitors • Controls • Resistors • Semiconductors • Sonalert® • Switches • Timers • Vibrators • ICs
Circle 10 on reader service card

New & Timely

(continued from page 2)

anode. It takes the place of a man's eye behind a secondary-electron-conduction (SEC) scope, displaying a 5X image. Unlike CRT's, the tube does not have a raster-like scan. Developmental versions cost \$6000 at this stage.

some 650,000 n-type islands on a quarter-size p-type silicon wafer. The light-sensitive wafer can easily provide a TV image of a smoker from the glow of a cigarette.

RCA presented a combination SEC and silicon-target vidicon with an image gain of

SATELLITE TV

A stationary applications satellite will be beaming TV directly to millions of Indian villagers in 1972 if all goes according to plan. The joint U.S.-Indian plan calls for thousands of 10-foot dish antennas costing only \$500 to be installed in villages.

These antennas will receive transmissions from a 30-foot antenna on a satellite capable of beaming a concentrated TV signal to earth from a 22,300-mile equatorial orbit. An 80-watt transmitter is planned for the satellite.

Programs planned by the Indian Government will be beamed to the satellite from a ground station.

SUPERPOWERFUL LASER TRIGGERS FUSION

PARIS—A superpowerful laser has been used by the French Atomic Energy Commission to create minute thermonuclear explosions. The laser, capable of delivering 50-billion-watt pulses for 5 nsec, was used to fuse deuterium nuclei held near absolute zero.

The fusion energy released in the form of neutrons is difficult to detect because of its low level. The

(continued on page 12)

X-RAY BURNS REPORTED AT NEA CONFERENCE

WATERBURY, CONN.—X-radiation from color TV sets under repair was blamed for burns and eye damage by technicians attending the annual National Electronic Association conference. According to two technicians, permanent damage to their right eyes had been caused by being too close to the CRT screen during convergence. Another technician, who habitually laid his left arm on top of sets while making adjustments, claimed he had developed a type of skin cancer on his forearm.

A G.E. representative pointed out that ordinary safety glasses can significantly reduce X-rays reaching eyes. G.E. and other set manufacturers indicated new chassis have been engineered for minimum radiation. Misadjusted or excessively high voltage is the prime cause of high X-ray levels in color TV.

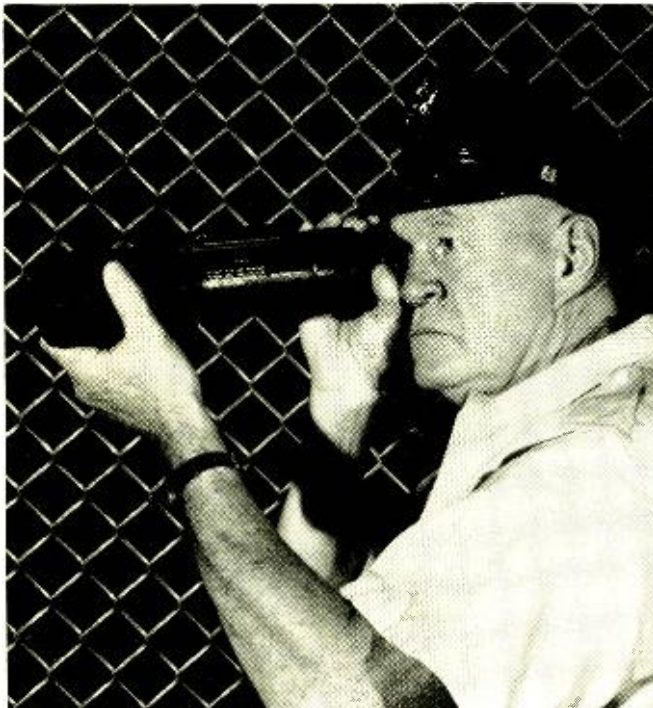

Also at the electro-optical conference, Amperex introduced a silicon-diode-array camera tube similar to those first developed at Bell Labs. Unlike conventional vidicons, the sensing mosaic consists of

2500. The combination technique provides 600 TV line resolution at 2×10^{-5} foot candles. RCA's C21117B uses the silicon array for the photoelectron-sensing SEC target. It will be available in mid-1970.

IN THIS ISSUE

Experiment with MOSFETS. Complete details on a group of useful circuits you can build and use. Story starts on page 61.

Radio-Electronics

HUGO GERNSBACK (1884-1967)
founder

M. HARVEY GERNSBACK,
editor and publisher

LARRY STECKLER, managing editor

Robert F. Scott, W2PWC
senior technical editor

John R. Free, associate editor

Jack Darr, service editor

I. Queen, editorial associate

Matthew Mandl, contributing editor

David Lachenbruch, contributing editor

Vincent P. Cicenia, production manager

Elizabeth Shincel, production assistant

H. Matysko, circulation

Cover by Harry Schlack

RADIO-ELECTRONICS is published by Gernsback Publications, Inc. 200 Park Ave. South New York, N.Y. 10003 (212) 777-6400

President: M. Harvey Gernsback
Secretary: Bertina Baer

ADVERTISING REPRESENTATIVES

EAST
John J. Lamson, Eastern Sales Mgr.

MIDWEST
Ralph Bergen,
J. E. Publishers Representative Co.
8 S. Michigan Ave., Room 720
Chicago, Ill. 60603
(312) 641-5744

W. COAST/Texas/Arkansas/Oklahoma
J. E. Publishers Representative Co.,
8380 Melrose Ave., Los Angeles,
Calif. 90069, (213) 653-5841;
420 Market St. San Francisco, Calif.
94111, (415) 981-4527

SOUTHEAST
E. Lucian Neff Associates
25 Castle Harbor Isle
Fort Lauderdale, Florida 33308
(305) 566-5656

SUBSCRIPTION SERVICE: Send all subscription orders and correspondence to RADIO-ELECTRONICS, Subscription Department, Boulder, Colo. 80302.

MOVING? For change of address, allow six weeks, furnishing both the old and new addresses and if possible attaching label from a recent issue below. Otherwise please print clearly your name and address exactly as it appears on your label.

ATTACH LABEL HERE

name (please print)
address
city state zip code

Mail to: RADIO-ELECTRONICS
SUBSCRIPTION DEPT., BOULDER, COLO. 80302

RADIO-ELECTRONICS

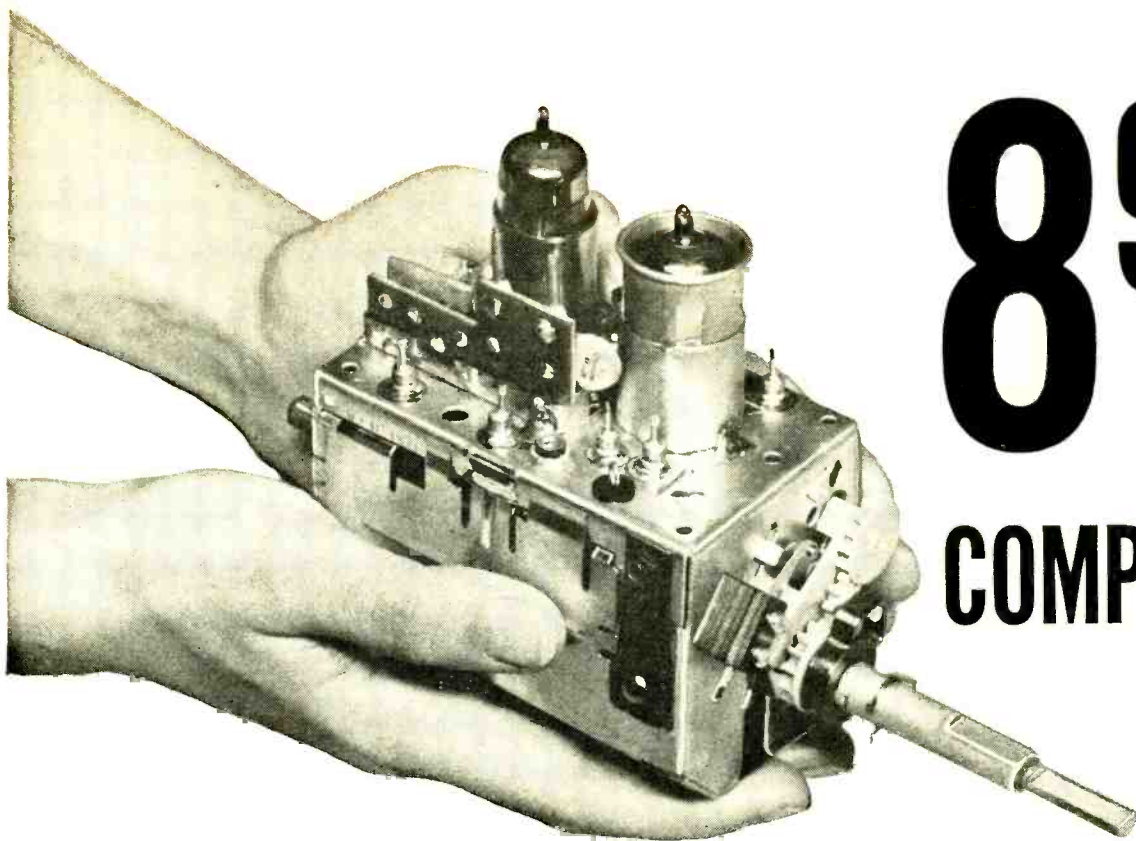

895 COMPLETE

Castle, the pioneer of television tuner overhauling, offers the following services to solve ALL your television tuner problems.

● **OVERHAUL SERVICE** — All makes and models.
(1960, or later)

- VHF or UHF tuner \$9.95
- UHF-VHF combination (one piece chassis) \$9.95
- TRANSISTOR tuner \$9.95
- COLOR tuner \$9.95
(Guaranteed color alignment . . . no additional charge)

Overhaul includes parts, except tubes and transistors.

Simply send us the defective tuner complete; include tubes, shield cover and any damaged parts with model number and complaint. Your tuner will be expertly overhauled and returned promptly, performance restored, aligned to original standards and warranted for 90 days.

UV combination tuner must be single chassis type; dismantle tandem UHF and VHF tuners and send in the defective unit only.

And remember—for over a decade Castle has been the leader in this specialized field . . . your assurance of the best in TV tuner overhauling.

Remove all accessories . . . or dismantling charge will apply.

● **CUSTOM REPLACEMENTS**

Exact replacements are available for tuners that our inspection reveals are unfit for overhaul. As low as \$12.95 exchange. (Replacements are new or rebuilt.)

● **UNIVERSAL REPLACEMENTS**

Prefer to do it yourself?

Castle universal replacement tuners are available with the following specifications.

STOCK No.	HEATERS	SHAFT		I.F. OUTPUT		PRICE
		Min.*	Max.*	Snd.	Pic.	
CR6P	Parallel 6.3v	1¾"	3"	41.25	45.75	8.95
CR7S	Series 600mA	1¾"	3"	41.25	45.75	9.50
CR9S	Series 450mA	1¾"	3"	41.25	45.75	9.50
CR6XL	Parallel 6.3v	2½"	12"	41.25	45.75	10.45
CR7XL	Series 600mA	2½"	12"	41.25	45.75	11.00
CR9XL	Series 450mA	2½"	12"	41.25	45.75	11.00

*Selector shaft length measured from tuner front apron to extreme tip of shaft.

These Castle replacement tuners are all equipped with memory fire tuning, UHF position with plug input for UHF tuner, rear shaft extension and switch for remote control motor drive . . . they come complete with hardware and component kit to adapt for use in thousands of popular TV receivers.

Order universal replacements out of Main Plant (Chicago) only.



CASTLE TV TUNER SERVICE, INC.

MAIN PLANT: 5715 N. Western Ave., Chicago, Illinois 60645
EAST: 41-96 Vernon Blvd., Long Island City, N.Y. 11101

Circle 11 on reader service card

Electronics comes alive with NRI Training Kits

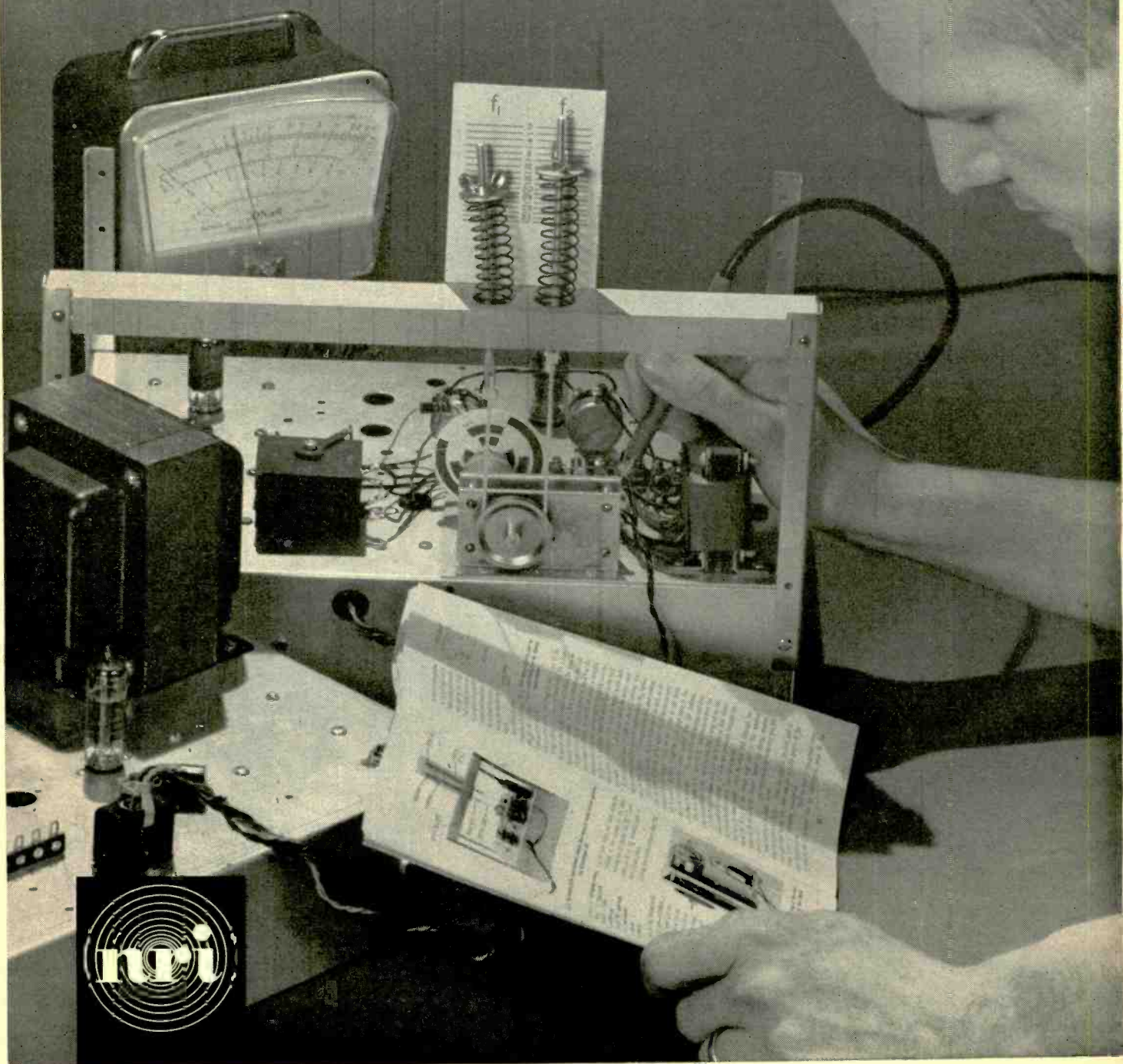

DISCOVER THE EASE AND EXCITEMENT OF TRAINING AT HOME THE NRI WAY

New Achievement Kit—Custom Training Kits—"Bite Size" Texts

Only NRI offers you this pioneering method of simplified "3 Dimensional" home-study training in Electronics, TV/Radio and Broadcasting/Communications. It's a remarkable teaching idea unlike anything you have ever encountered, the result of more than half a century of simplifying, organizing and dramatizing learning-at-home techniques. If you are an ambitious man—regardless of your education—you can effectively learn the Electronics field of your choice the NRI way.

NRI has *simplified* Electronics by producing "bite size" lesson texts averaging only 40 pages each. Dozens of illustrations open wide a picture window through which you'll see and understand practical uses of Electronics. You start out with NRI's exclusive Achievement Kit, containing everything you need to get started fast. (Illustrated at right.)

NRI has *organized* Electronics training to take you step-by-step from the first stages into more intriguing areas. Once you know the fundamentals thoroughly, it's easy to grasp more advanced theory and techniques. You move with confidence and enthusiasm into a new adventure filled with the excitement of discovery.

NRI has *dramatized* Electronics through the careful development of special training equipment that is *programmed* into your training systematically . . . beginning with your first group of lessons. Things you read about come alive in your hands as you build, experiment, purposely cause "problems" in circuits—and solve them. You learn to use test equipment, to build radios and TV sets, transmitter, or computer circuits. It's the priceless "third dimension" in NRI training . . . practical experience.

More than 50 years of leadership
in Electronics Training

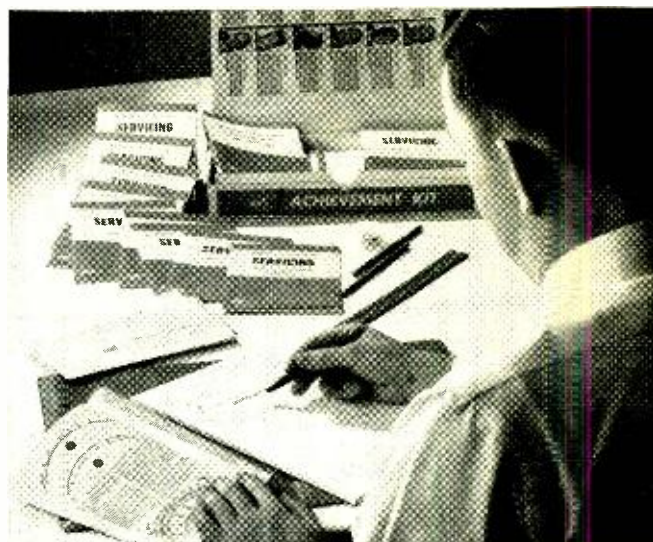

YOU GET MORE FOR YOUR MONEY FROM NRI

Mail postage-free card now for your free NRI catalog. Then, compare. You'll find—as have thousands of others—NRI training can't be beat. Read about the new Achievement Kit sent the day you enroll; about "bite-size" texts and custom designed training equipment. See why NRI gives you more value. Whatever your reason for wanting more knowledge of Electronics, NRI has an instruction plan for you. Choose from major programs in TV/Radio Servicing, Industrial Electronics and Complete Communications. Or select from special courses to meet specific needs. Check the course of interest to you on postage-free card and mail today for free NRI catalog. No salesman will call. NATIONAL RADIO INSTITUTE, Electronics Div., Washington, D.C. 20016.

Available Under
**NEW
GI BILL**

If you served since January 31, 1955, or are in service, check GI line in postage-free card.

Career? Part-Time Earnings? Hobby? Choose From 12 Training Plans

1. TELEVISION-RADIO SERVICING — Learn to fix all TV sets, including Color. Includes your choice of NRI Color Kit or 19" black-white TV Kit. Also covers radios, stereo hi-fi, etc. Profitable field spare or full-time.

2. INDUSTRIAL-MILITARY ELECTRONICS — Basics to computers. Starts with fundamentals, covers servos, telemetry, multiplexing, phase circuitry, other subjects.

3. COMPLETE COMMUNICATIONS* — Operation, service, maintenance of AM, FM and TV broadcasting stations. Also covers marine, aviation, mobile radio, facsimile, radar, microwave.

4. FCC LICENSE* — Prepares you for 1st Class FCC License exams. Begin with fundamentals, advance to required subjects in equipment and procedures.

5. MATH FOR ELECTRONICS — Brief course for engineers, technicians seeking quick review of essential math: basic arithmetic, short-cut formulas, digital systems, etc.

6. BASIC ELECTRONICS — For anyone wanting a basic understanding of Radio-TV Electronics terminology and components, and a better understanding of the field.

7. ELECTRONICS FOR AUTOMATION — Not for beginners. Covers process control, ultrasonics, telemetering and remote control, electromechanical measurements, other subjects.

8. AVIATION COMMUNICATIONS* — Prepares you to install, maintain, service aircraft in-flight and landing systems. Earn your FCC License with Radar Endorsement.

9. MARINE COMMUNICATIONS* — Covers electronic equipment used on commercial ships, pleasure boats. Prepares for FCC License with Radar Endorsement.

10. MOBILE COMMUNICATIONS* — Learn to install, maintain mobile transmitters and receivers. Prepares for FCC License exams.

11. ELECTRICAL APPLIANCE REPAIR — Learn to repair all appliances, including air conditioning, refrigeration, small gas engines. Leads to profitable part or full-time business.

12. ELECTRONICS FOR PRINTERS — Operation and maintenance of Electronic equipment used in graphic arts industry. From basics to computer circuits. Approved by major manufacturers.

* You must pass your FCC License exams (any Communications course) or NRI refunds in full the tuition you have paid.

THROW AWAY THE SOLDER or MY DADDY USES CUSS WORDS

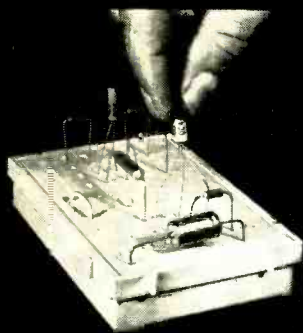

Some years ago two men, Mr. S. and Mr. deC had an idea. Wearing white hats they dutifully offered it to the giant electronics conglomerate under whose roof they laboured. He sneered so they left and developed it on their own.

It's a solderless breadboard and the secret lies in a precision clip of firm grasp and low resistance. These clips are leafspring contacts of phosphor bronze or silverplate.



As with all good things customers came up with more ideas using S-DeCs than the originators believed possible and the demand for added flexibility resulted in a box with two interlocking S-DeCs known as DeCSTOR, (pronounced Deck-Store). Not content with this, users circuits outgrew the DeCSTOR and so a 4-DeC kit was created for the man with ideas bigger than his breadboard. Today there is a whole range of DeC solderless breadboards covering conventional and integrated circuit requirements.

So, if you need to throw away the solder, keep the skin on your fingers and the black words buried down below, write to us for more information, or better still send us a check.

INTRATEC

399 Jefferson Davis Highway
Arlington, Virginia 22202

Please send me postage paid:

..... 5-DeC's	@ \$ 6.75 each
..... DeC STOR's	@ \$13.75 each
..... 4-DeC's	@ \$23.25 each

I enclose a check/money order for \$.....

Va. residents add 4% sales tax

I am interested in the IC versions. Send literature and prices.

Name

Address

City

State Zip Code

Box RE

Circle 13 on reader service card

New & Timely (continued from page 6)

laser blast raises the deuterium temperature to 15 million degrees Fahrenheit. Similar experiments have been conducted in the USSR and the U.S., according to a report in *The New York Times*.

ELECTRONIC TOOL SEES COLORS

Color blind? The Colormate 2000 might solve some of your problems, although the newly patented instrument was designed with the chemical and printing industries in mind.

The Colormate "sees" a

sample of a material as a human eye would by comparing it with a standard and recording any color differences. A sample color is identified by alternately shining light on the sample and a standard through amber, green and blue filters. A photocell receiving the reflected light then moves up or down until it receives equal light from both sample and standard.

A printout or chart indicates color changes needed to achieve a match. The electronic colormeter is made by Neotec Corp., a Rockville, Md., firm.

VOICE-OPERATED TYPEWRITER FOR PHYSICALLY HANDICAPPED

Poor typists who blame their mistakes on the typewriter would feel comfortable with this model—it's voice operated. An experimental set-up developed by a British division of ITT, it is being studied as an aid to

the physically handicapped. Up to 20 words per minute can be typed by "dit-dahing" Morse code sounds into the machine's microphone. It works, but there are no immediate plans for production.

(continued on page 14)



LOOKING AHEAD

(continued from page 4)

Mobile radio problems

The long-simmering problem of overcrowding in the mobile radio bands has taken a new turn. A special study made for the FCC by the Stanford Research Institute indirectly blamed the FCC for "inadequate frequency management." Mobile radio users and manufacturers have long insisted that insufficient spectrum space is available for land-mobile use and have requested the reassignment, or sharing, of a portion of the current uhf television band. The Commission now has pending proceedings for sharing of channels 14 through 20 between television and mobile radio and the reassignment of TV channels 70 through 83 to mobile radio use.

The Stanford report suggested that lack of FCC "management" of the mobile spectrum was largely responsible for overcrowding condition in some areas and under-utilization of fre-

(continued on page 14)

Circle 14 on reader service card ➤

RADIO-ELECTRONICS

The RCA rotator has many features your customers won't understand. It has one that everyone recognizes: the name, RCA.

RCA engineers have produced the best in rotators. Beautiful, easy to operate control cabinets. Rugged, durable drive units. And they're tested. Continuous operation life-tested, under conditions no rotator would ever encounter in normal use.

The "extra feature" in every RCA rotator is the name . . . RCA. It's the feature your customers recognize, rely upon. It's taken over fifty years to build this kind of acceptance . . . acceptance that means more sales for you.

RCA
Rotators

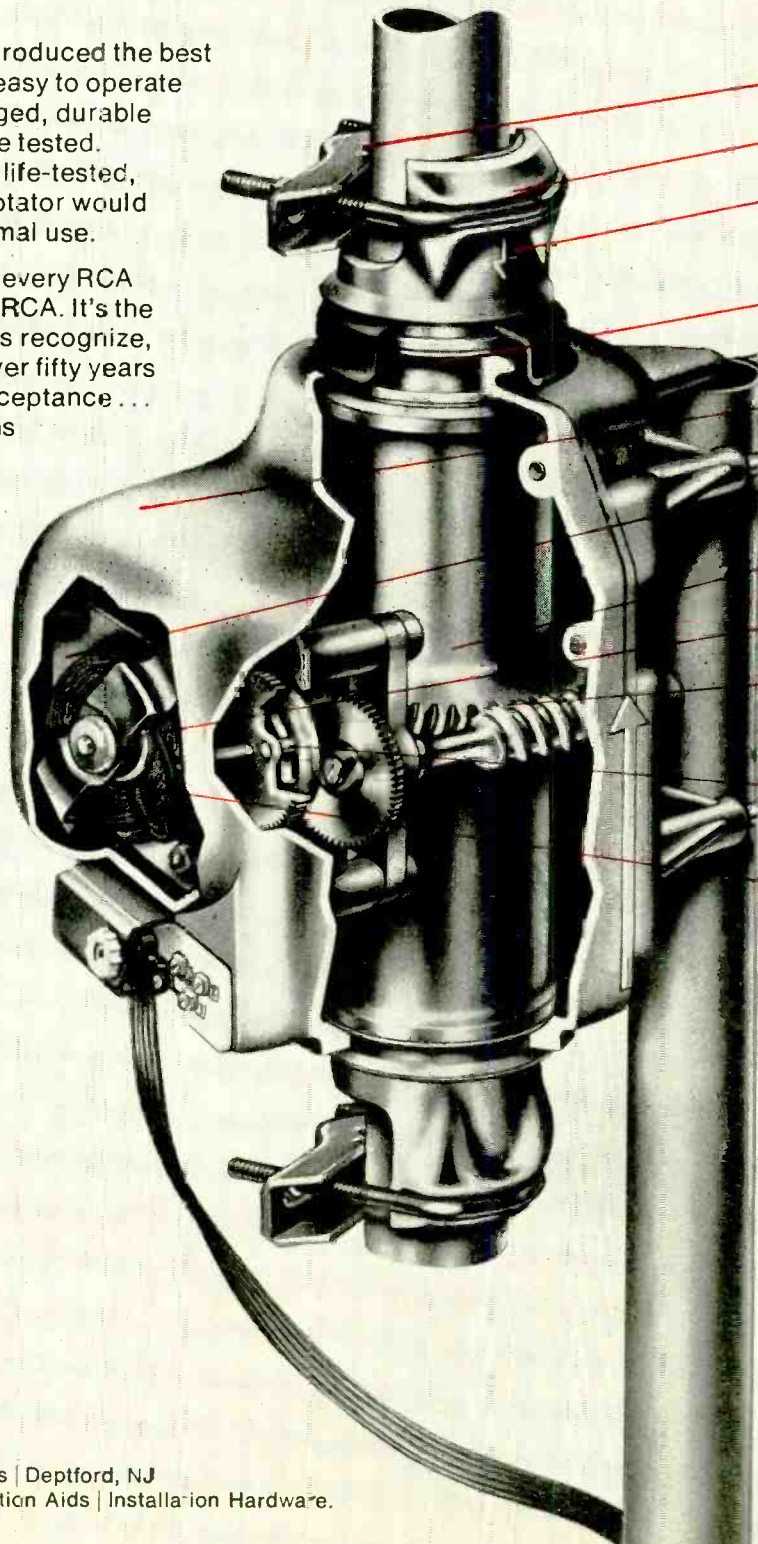

V-block serrated clamping system locks mast securely.

Reinforced shaft has nested "U" bolt.

Center-position alignment markers speed installation.

Stainless steel bearings are permanently lubricated. No external thrust bearings required.

High-tensile aluminum housing is rugged, lightweight for less inertial loading on mast.

High-temperature insulation on motor allows continuous operation.

Main drive gear is cast integral to main shaft; can't loosen.

Positive disc brake on motor prevents "overshoot."

Positive worm drive prevents windmilling.

Overtravel clutch permits motor to run before load is engaged—for pre-turning momentum.

High-efficiency motor consumes less power; less voltage drop over long cable runs.



Model 10W707

The RCA fully automatic Rotator has solid state circuitry for positive synchronization. Positive directional indicator lights. Silent operation.



Model 1CW505

The RCA positive push-button fingertip control Rotator with 360° indicator dial. Unique design assures precise control with few moving parts. RCA performance and quality at a modest price!

RCA | Parts and Accessories | Deptford, NJ
Rotators | Antennas | Reception Aids | Installation Hardware.

We defy competition

to top Oxford quality, variety, delivery, and prices!

Here are the speakers with the quality features demanded for today's critical sound requirements. Extra heavy ceramic magnets for wider range, with Oxford's exclusive "Floating Suspension Surround" the permanently flexible edge that extends the low frequency spectrum without undesirable hangover, assuring smoother mid-range, brilliant high frequency response.



Paging and Talk Back Speakers



Public Address Speakers



"TEMPO" Hi-Fi Speaker



All Weather Speakers



Replacement Speakers



Professional Musical Instrument Speaker

Match your needs from a full range of speakers for new highs in high fidelity performance. Best of all, they're available now from—

OXFORD.
of course.

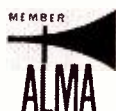

Write for complete information today!
OXFORD TRANSDUCER COMPANY
A Division of Oxford Electric Corporation



Circle 15 on reader service card

New & Timely

(continued from page 12)

FOUR CHANNEL STEREO IS HERE ON TAPE AND AIRWAVES

NEW YORK—Four-channel or "surround" stereo went public in September with the conversion of Acoustic Research Inc.'s Grand Central Terminal listening room to a 4-channel setup.

The AR demonstration used a 4-channel Telex tape deck model and AR4x speakers for the two rear channels. Most people who have heard 4-channel demonstration have been impressed by the additional presence the rear speakers add.

Vanguard now has a number of 4-channel tapes on the market, and Telex demonstrated a tape deck for less than \$300 at the Los Angeles Hi-Fi Show in October. Scott is already marketing a 4-channel amplifier.

The new sound is still experimental. FM stereo broadcasts using two stations (and

requiring 2 tuners) have been tried in Boston and New York. According to a *Television Digest* report, a 4-channel broadcast using an FM subcarrier for the rear channels was planned for October 26 over New York's WNYC. This setup requires only modifications of SCA equipment, and does not alter the main stereo broadcast. Record discs have also been made by multiplexing the left and right stereo channels with the rear channels and decoding the output of a normal cartridge.

Microphone placement for most 4-channel tapes will be to pick up reflections from rear and side walls not reproduced in 2-channel stereo. But gimmick or rock recordings may place the mikes between or among the recording group to bring even more presence to the tape. **R-E**

LOOKING AHEAD

(continued from page 12)

quencies in others, and indicated the belief that proper use of the present spectrum might relieve most of the congestion problems.

Radiation and TV viewers

The Bureau of Radiological Health has released a rather reassuring study of the calculated effects of color TV radiation on television viewers, based on average annual viewing and average viewing distances, as observed in home tests in the Washington, D.C., area. The tests showed that the average color set radiated about 0.05 mR per hour at 5 cm, or approximately 1/10 the limits established by health authorities. At that rate, the average doses from viewing color TV to critical areas of the body would all be well below one-half of one percent of the suggested limit of radiation established by the National Council on Radiation Protection and Measurements. Even from sets emitting 0.5 mR per hour, the Bureau said, radiation would be below the recommended limit of 5% of the average dose from natural background sources (buildings, pavement, atmosphere, etc.).

How many 1969 models?

The 1970 model sets are here, and it's time to take stock of how the 1969's did. Not so bad, it turns out. American sales of 1969-model color TV totaled about 6,450,000 sets, including imports, an increase from 5,700,000 of the 1968 models. Some 6,100,000 black-and-white sets were sold during the 1969 model year, as compared to 5,963,000 in the preceding year.

Phonograph sales were up slightly, totaling 5,563,000 American-branded units. **R-E**

The New 1970 Improved Model 257 **A REVOLUTIONARY NEW**
TUBE TESTING OUTFIT

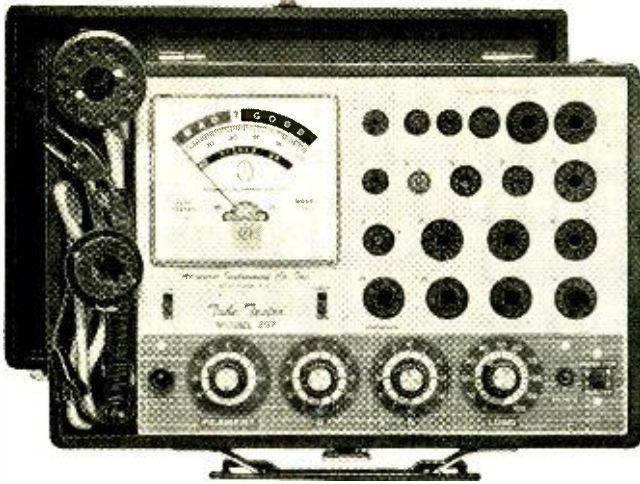

- Tests all modern tubes including Novars, Nuvistors, Compactrons and Decals.

- All Picture Tubes, Black and White and Color

ANNOUNCING...for the first time

A complete TV Tube Testing Outfit designed specifically to test all TV tubes, color as well as standard. Don't confuse the Model 257 picture tube accessory components with mass produced "picture tube adapters" designed to work in conjunction with all competitive tube testers. The basic Model 257 circuit was modified to work compatibly with our picture tube accessories and those components are not sold by us to be used with other competitive tube testers or even tube testers previously produced by us. They were custom designed and produced to work specifically in conjunction with the Model 257.

COMPLETE WITH ALL ADAPTERS AND ACCESSORIES, NO "EXTRAS"

STANDARD TUBES:

- ✓ Tests the new Novars, Nuvistors, 10 Pins, Magnovals, Compactrons and Decals.
- ✓ More than 2,500 tube listings.
- ✓ Tests each section of multi-section tubes individually for shorts, leakage and Cathode emission.
- ✓ Ultra sensitive circuit will indicate leakage up to 5 Megohms.
- ✓ Employs new improved 4½" dual scale meter with a unique sealed damping chamber to assure accurate, vibration-less readings.
- ✓ Complete set of tube straighteners mounted on front panel.

BLACK AND WHITE PICTURE TUBES:

- ✓ Single cable used for testing all Black and White Picture Tubes with deflection angles 50 to 114 degrees.
- ✓ The Model 257 tests all Black and White Picture Tubes for emission, inter-element shorts and leakage.

COLOR PICTURE TUBES:

- ✓ The Red, Green and Blue Color guns are tested individually for cathode emission quality, and each gun is tested separately for shorts or leakage between control grid, cathode and heater. Employment of a newly perfected dual socket cable enables accomplishments of all tests in the shortest possible time.

The Model 257 is housed in a handsome, sturdy, portable case. Comes complete with all adapters and accessories, ready to plug in and use. No "extras" to buy. Only

\$52.50

NOTICE

We have been producing radio, TV and electronic test equipment since 1935, which means we were making Tube Testers a time when there were relatively few tubes on the market, way before the advent of TV. The model 257 employs every design improvement and every technique we have learned over an uninterrupted production period of 34 years.

Accurate Instrument Co., Inc.

SEND NO MONEY WITH ORDER
PAY POSTMAN NOTHING ON DELIVERY

Try it for 10 days before you buy. If completely satisfied remit \$52.50 plus postage and handling charge. (If you prefer you may **PAY MONTHLY ON OUR EASY PAYMENT PLAN.**) If not completely satisfied, return to us, no explanation necessary.

ACCURATE INSTRUMENT CO., INC.

Dept. 712

2435 White Plains Road, Bronx, N. Y. 10467

Please rush me one Model 257. If satisfactory I agree to pay at the terms specified at left. If not satisfactory, I may return for cancellation of account.

Name _____

Address _____

City _____ Zone _____ State _____

Save Money! Check here and enclose \$52.50 with this coupon and we will pay all shipping charges. You still retain the privilege of returning after 10 day trial for full refund.

Circle 16 on reader service card

HOPPING ALL OVER TOWN FOR REPLACEMENT PARTS . . .

Just hop to
STANCOR...

for all your exact monochrome
and color TV replacement needs.

Stancor Products offer a complete
line of flybacks, yokes, vertical out-
puts, audio outputs, power width
and linearity controls for all major
manufacturers.

Stocked by over 1,000 Service Part Dis-
tributors. Back up stock—Chicago, Dallas,
Los Angeles, Hackensack and Atlanta.



ESSEX INTERNATIONAL, INC. CONTROLS DIVISION, 3501 W. ADDISON ST., CHICAGO, ILL. 60618

Circle 17 on reader service card

America's Top-Rated Stereo Kits Now a Best Buy!*



*LT-112B-1
FM Stereo Monitor Tuner Kit:
Now \$149.95

LK-60B
160-Watt Stereo Amplifier Kit:
Now \$149.95

LR-88
135-Watt AM/FM Stereo Receiver Kit:
Now \$299.95

SCOTT

Write for new Scott Kit Catalog.
H. H. Scott, Inc., 111 Powdermill Road,
Maynard, Mass. 01754. © 1969, H. H. Scott, Inc.

POPULAR SCIENCE SAYS:

"... How does it perform? In a word, flawlessly; stereo performance is superb, and the set's sensitivity will cope with the deepest fringe-area reception conditions . . . I rate the LT-112B as one of the finest FM tuners available — in or out of kit form."

STEREO REVIEW SAYS:

"We measured the IHF sensitivity of the Scott LT-112B tuner as 1.4 microvolts, which certainly makes it one of the most sensitive tuners we have encountered."

AMERICAN RECORD GUIDE SAYS:

"Scott LT-112B tuner must be placed in the very top echelon of today's components."

AUDIO SAYS:

"Here's a stereo FM/AM receiver kit with a real hot front end, fairly high power output, low distortion, and excellent operating flexibility . . . The Scott LR-88 offers a most competent design at a price well below that for an equivalent factory-assembled unit."

ELECTRONICS ILLUSTRATED SAYS:

"One of the finest examples of solid-state integrated-amplifier kit design, packaging and performance we have seen in the Scott LK-60."

HIGH FIDELITY SAYS:

"... an unprecedented high sensitivity, one which surprised even us . . . This is certainly a tuner for use in the most difficult of reception areas; stations seem to pop in all across the tuner dial."

Circle 100 on reader service card

In the Shop . . . With Jack

By **JACK DARR**
SERVICE EDITOR

Sherlock And The Schematically Impossible

THERE ARE THINGS, HORATIO, WHICH are not explainable even in thy philosophy. Especially in the bewildering business of electronics repairing. We run into them every day. How well we get along depends on how flexible we can be. We simply have to keep an open mind at all times or we're dead. A lively imagination is a big help in this business.

Since we do detective work for a living, we need to remember what the greatest detective of them all said: "Consider all the evidence. Then, when you have eliminated all but one of the possibilities, the one which remains must be right." Sherlock Holmes wouldn't recognize that quotation in that form, but he did say it.

COMMON
CATHODE

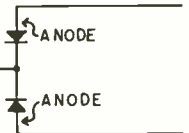

To illustrate this, take the Case Of The Tunerless TV. While fiddling around with it trying to find out what was wrong, I disconnected the tuner completely. Somehow I happened to feed the signal (from a cable system antenna) directly into the open i.f. input. I got a pretty fair picture on Ch. 4. sound and all!

Hmm. How-come? Trf video i.f. aligned on Ch. 4 or something? No! Normal i.f. signal goes through as it should. What's happening? Investigation disclosed that the 3rd i.f. stage was oscillating, and evidently at a frequency which beat with the Ch. 4 rf carriers to make a picture. The cure was obvious. Watson. Stop the oscillation. (Open screen bypass.)

The Case of the Schematically Impossible Horizontal Afc was another one and probably a better illustration of the point. This set had practically no horizontal stability, in a strictly stock horizontal afc circuit. So I went through all of the stock tests. Pulses, waveforms, n-p voltages, and everything checked out ok. Dc voltage on the "afc grid" wasn't, of course, since this was the root cause of the horizontal instability.

So take it apart. Open the coupling capacitors and check on the

(continued on page 22)

Circle 19 on reader service card →

Now... **everyone** in your family can watch the TV shows they want... **where** they want... **when** they want!

NEW JFD®

ELECTRONIC HOME ENTERTAINMENT PROGRAM CENTER KIT

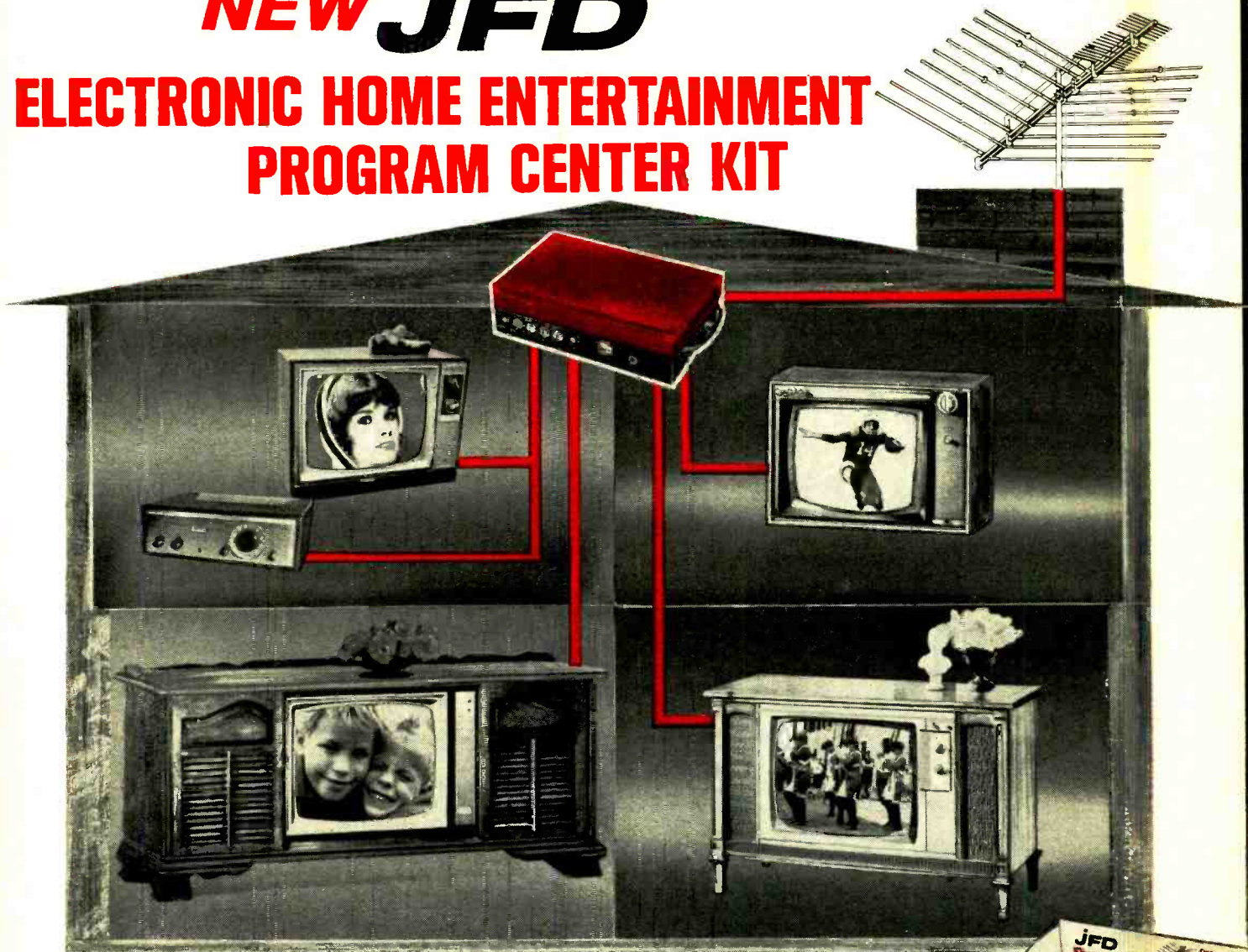

*makes wiring your home for picture-perfect multi-set operation—
from one antenna—quick and easy.*

- Provides up to four TV sets throughout your home with *different* programs.
- Delivers picture-perfect *Color* or black-and-white TV on channels 2 to 83—plus *FM* mono or stereo to hi-fi systems.
- *Easy-to-install kits*—complete with amplifier, parts and instructions—available to satisfy every location.
- Conveniently packaged in compact *carry-home* attaché carton.
- Also enables you to *move any of your portable* TV sets from room to room and plug it into the JFD system.

MAIL COUPON TODAY!

JFD ELECTRONICS CORP.
1462 62ND STREET
BROOKLYN, NEW YORK 11219

- Rush me more information.
- Also furnish name of my nearest Program Kit dealer.

Name _____ (please print)

Address _____

City _____ State _____ Zip _____



JFD ELECTRONICS CORP.—a subsidiary of Riker-Maxson Corp. — world leader in home entertainment antenna systems

When things slow down, who's first to go?

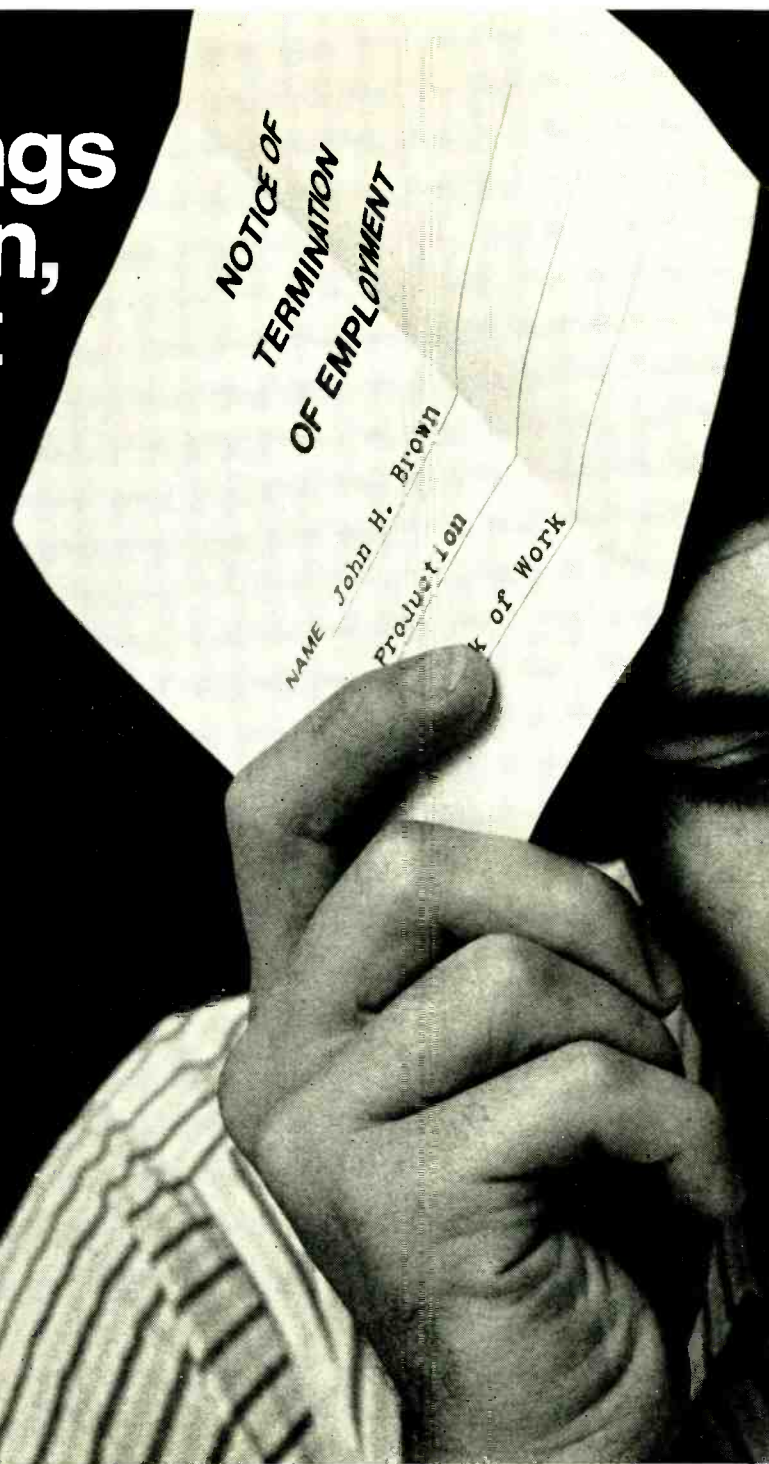

If you work in electronics, you know the answer.

Men who know only enough to handle routine jobs are expendable. They're easily replaced when things pick up. But no company wants to lose men who combine experience with advanced, specialized education in electronics.

Make yourself one of these valuable specialists. Get the additional education in electronics you need to enjoy challenging work, high pay, and excellent security for yourself and your family.

Going back to school isn't easy for a man with a full-time job and family obligations. But CREI Home Study Programs make it possible for

you to get the additional education you need without attending classes. You study at home, at your own pace, on your own schedule. You study with the assurance that what you learn can be applied to the job immediately.

CREI Programs cover all important areas of electronics including communications, radar and sonar, even missile and spacecraft guidance. You're sure to find a program that fits your career objective, whether it be in research, production, operation or maintenance.

You're eligible for a CREI Program if you work in electronics and have a high school education. Our FREE book gives complete

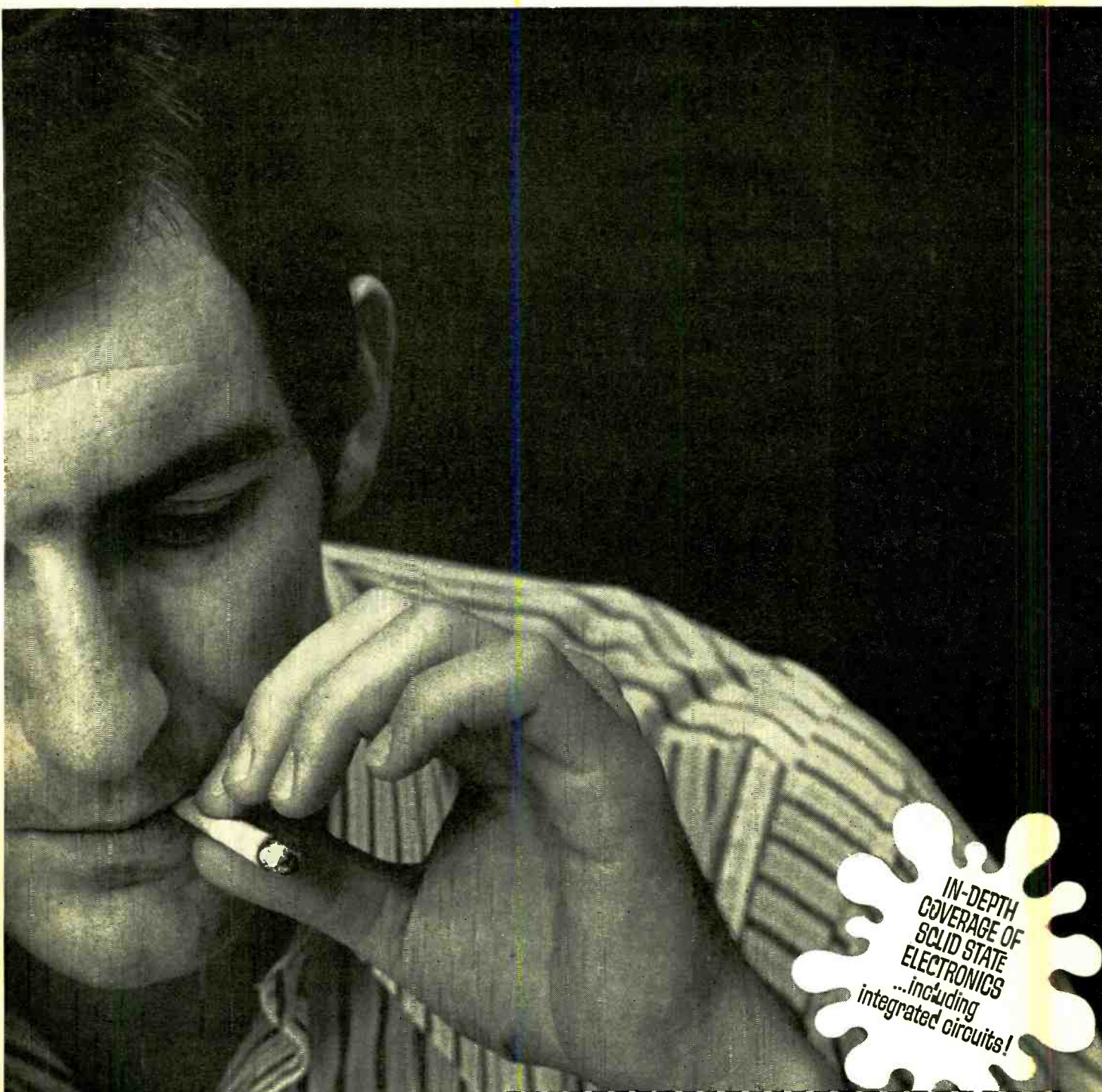

**IN-DEPTH
COVERAGE OF
SOLID STATE
ELECTRONICS**
...including
integrated circuits!

information. Mail postpaid card for your copy today. If card is detached, use coupon or write: CREI, Dept. 1412H, 3224 Sixteenth Street, N.W., Washington, D.C. 20010.

Founded 1927

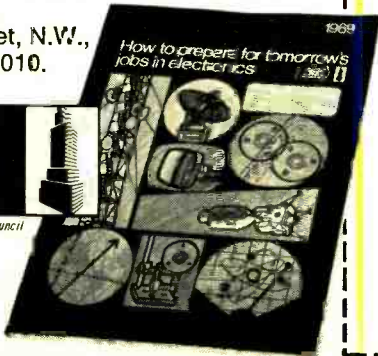

**CREI, HOME STUDY DIVISION
McGRAW-HILL BOOK COMPANY**

Dept. 1412H, 3224 Sixteenth Street, N.W.,
Washington, D.C. 20010

Please mail me FREE book describing CREI Programs. I am employed in electronics and have a high school education.

Name _____ Age _____

Address _____

City _____ State _____ Zip _____

Employed by _____

Type of Present Work _____ G.I. Bill

- I am interested in: Electronic Engineering Technology
 Computers Space Electronics
 Nuclear Engineering Technology Industrial Automation

APPROVED FOR TRAINING UNDER NEW G.I. BILL

LOOKING FOR ACCURACY?

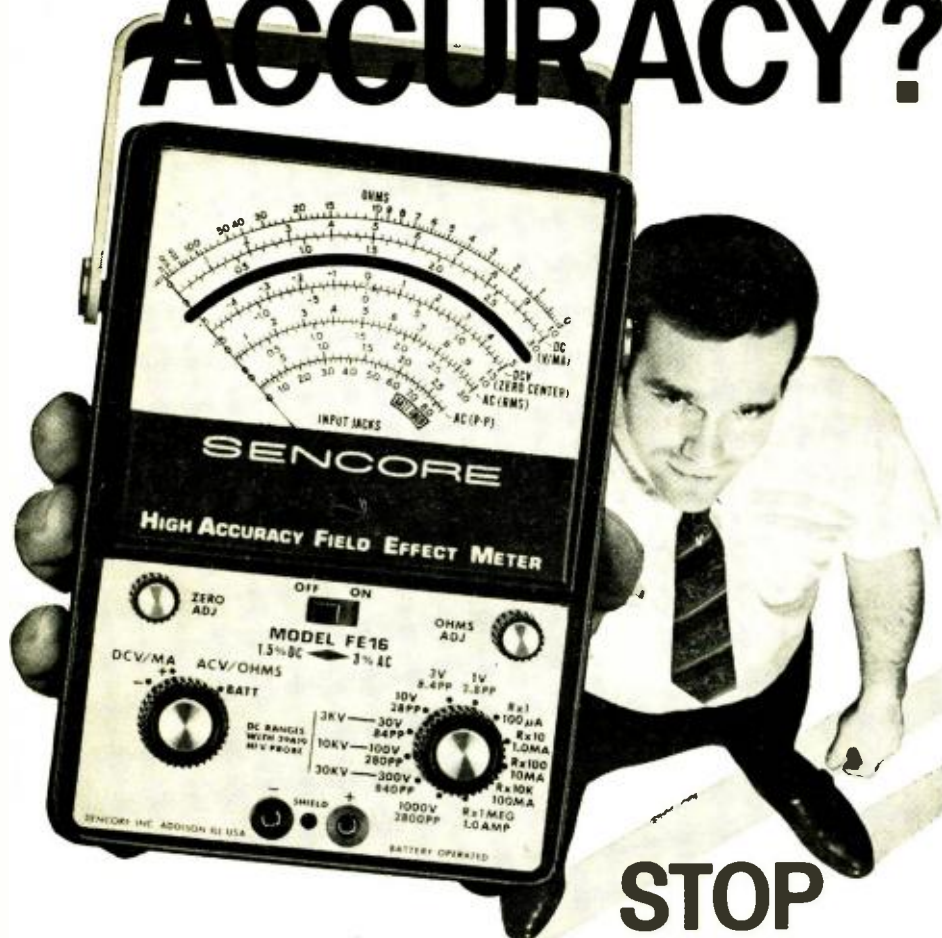

STOP RIGHT HERE!

Take a close look at a revolutionary new multimeter. The Sencore Field Effect Meter. This beautifully styled FE meter virtually obsoletes all VTVMs and VOMs. Why? Exclusive FET circuitry. A totally new concept in multimeter design that prevents circuit loading. Interested? Here's more. The FE16's 15 megohm input impedance on DC and 10 megohm on AC is 750 times less loading than a standard 20,000 ohm/volt VOM, 50% less loading than a standard VTVM on DC volts and 10 times less loading on AC volts. Here's a real package of dynamite that means accuracy. FET ACCURACY that's 1.5% on DC, 3% on AC. (An unbelievable 1/2% full scale accuracy on 1 VDC.)

Want more? Look a little closer. An exclusive true zero center scale starting at $\pm .5V$ DC, DC current ranges from $100\mu A$ to 1-amp, complete meter and circuit overload protection, mirror back scale, built-in battery check, rugged vinyl clad all steel case, and . . . that's it. If you still want a closer look, you'll have to buy it. Remember the name **FIELD EFFECT METER**. Only Sencore makes them. Your Distributor has them in stock at \$84.50—less than the cost of a good VOM or VTVM.



SENCORE

NO. 1 MANUFACTURER OF ELECTRONIC MAINTENANCE EQUIPMENT

426 SOUTH WESTGATE DRIVE, ADDISON, ILLINOIS 60101

Circle 21 on reader service card

IN THE SHOP

(continued from page 16)

open end for the sync and comparison pulses. Good. Nice clean waveforms, right p-p voltage, etc. One down. Take resistance readings around the circuit. Pretty good. No shorts to ground, etc, although they didn't look just right.

Check the diode with ohmmeter, in-circuit. Looks good. Diode-readings on the common-cathode unit showed that both diodes were ok. Well! Take the diode out and check it on the transistor-tester to make sure. Ok, fine. Both diodes show nice high reverse resistance, low forward resistance, and they match. Put it back in. Same as before. Very narrow horizontal hold range although the picture would hold fairly well once locked in, and it would hold without the afc, showing that the oscillator itself was running as it should, and not trying to pull out of range. This was an afc trouble, but where?

Well, do it over again. You've missed something. The resistances around the diode circuit looked odd. So out with the diode again. Check with ohmmeter. Hey! What's this? While checking, I'd left one ohmmeter clip on one of the anodes, then moved the cathode clip to the other anode. Hey! Short? Yes! Nice dead short. From ANODE TO ANODE? Yes sir. A new diode cleared up the trouble.

Now what happened? *Schematically*, this is impossible (Fig. 1). The anodes are the terminals *farthest apart*. They can't short to one another! But they did. The answer is, of course, that this is an optical illusion, caused by the way the diodes are *drawn* in a schematic. In the actual diode chip, it is quite possible for an anode to anode short to take place (Even I could see this for it just *did!*) The chip doesn't look anything like the schematic representation of the thing. So, this can give you a mental block as to considering such possibilities.

Keeping a really wide-open mind can be a big help when trying to diagnose such complaints. If you will freely admit the possibility that *anything* can happen, and probably will, you won't be apt to overlook things like this. For example, wires that are far apart on a schematic can actually be about 15 thousandths of an inch apart on the chassis itself, and easy to short together with a tiny bit of solder, etc., etc.

Keep the mind open: when you have eliminated all of the possible causes except one, that has to be it. Thanks, Sherlock!

R-E



DELTA will tell you *everything!* — Complete Specs including schematics!

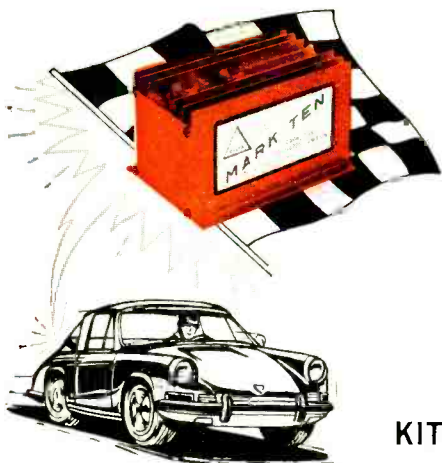

MARK TEN[®] SCR

CAPACITIVE DISCHARGE IGNITION SYSTEM

Now discover for yourself the dramatic improvement in performance of your car, camper, jeep, truck, boat — any vehicle! Delta's remarkable electronic achievement saves on gas, promotes better acceleration, gives your car that zip you've always wanted. Find out why even Detroit has finally come around. In five years of proven reliability, Delta's Mark Ten has set new records of ignition benefits. No re-wiring! Works on literally any type of gasoline engine.

- ▲ Dramatic Increase in Performance and in Fast Acceleration
- ▲ Promotes More Complete Combustion
- ▲ Points and Plugs Last 3 to 10 Times Longer
- ▲ Up to 20% Mileage Increase (saves gas)

KIT FORM **\$29⁹⁵**

12V ONLY

ASSEMBLED **\$44⁹⁵**
ONLY ppd.

MODEL 3000 FET VOM

Delta now offers a compact, versatile, and extremely sensitive VOM which combines FETs and ICs for extreme accuracy. Compact (6½"W x 8"H x 3½"D), portable. Wt. 3¾ lbs.

IN KIT FORM: Feedback network with pre-selected components to eliminate all final calibration. Ready to use when assembled!

NEW DELTA FEATURES:

- ▲ Mirror scale 200 A D'Arsonval meter
- ▲ Integrated circuit (IC) operational amplifier for extreme accuracy
- ▲ FET input stage with current regulator
- ▲ Two stage transistor current regulator and Zener diode on OHMS for absolute stability and accuracy
- ▲ Voltage clippers for protection of input stage
- ▲ Fully temperature compensated for low low zero drift
- ▲ Ten turns ZERO and OHMS adjust potentiometers
- ▲ Epoxy glass circuit boards and metal case
- ▲ Enclosed switches
- ▲ Uses readily available type AA cells
- ▲ Uses standard test leads for maximum flexibility and ease of measurement
- ▲ 10 Megohms input impedance

ONLY

\$74⁹⁵
ppd.

Only **\$59⁹⁵**
ppd.

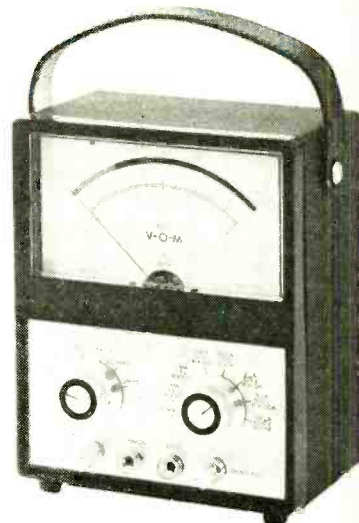

COMPUTACH[®]

Delta, pioneers in CD ignition who produced the fabulous MARK TEN[®], now offer a precise computer-tachometer which obsoletes any type tachometer on the market today! You achieve unbelievable accuracy in RPM readings due to the advanced, solid-state electronic matched components used in the computer, coupled with the finest precision meter in the world. Works on all 2, 3, 4, and 6 cylinder 2 cycle and with 4-6-8 cylinder — 4 cycle 12 volt engines.

- ▲ 0-8000 RPM range
- ▲ Perfect linearity — zero parallax
- ▲ Adjustable set pointer
- ▲ Wide angle needle sweep
- ▲ Translucent illuminated dial
- ▲ Chrome plated die-cast housing
- ▲ All-angle ball & socket mounting
- ▲ Use it with ANY ignition system
- ▲ Meter: 3½" dia. X 3¾" deep
- ▲ Calibration kit included, no test eqpt. needed.

*An exclusive computer-tachometer for precise RPM measurement in easy-to-build Kit form! **\$29⁹⁵**
ppd.

Write today for complete literature packet

KIT FORM ONLY

DP 9-B

DELTA: Please send me literature immediately.

I am enclosing \$_____ for items checked.

- Mark Ten SCR Kit Assembled
- Model 3000 FET VOM Kit Assembled
- Computach (Kit only)

Please ship immediately.

Name _____

Address _____

City/State _____ Zip _____

*My car is (Model) _____ (Year) _____



DELTA PRODUCTS, INC.

P.O. BOX 1147 • GRAND JUNCTION, COLORADO 81501

the new SANSUI AU555



The AU555 by Sansui is an outstanding, professional control amplifier. 60 watts (IHF) of music power, bandwidth from 20 to 30,000 Hz and a distortion factor of less than 0.5% assure you of clean sound reproduction. The Sansui AU555 offers almost unlimited versatility with its pre- and main amplifier sections designed for independent usage, 2-adjustable speaker damping factors, 4-position speaker selector switch, 4-outputs and 7-inputs, and much, much more . . . At your franchised Sansui dealer. \$159.95.

sansui

SANSUI ELECTRONICS CORP. Woodside, New York, 11377 • Los Angeles, California, 90007
SANSUI Electric Co., Ltd., Tokyo, Japan • European Office Frankfurt a.M., West Germany
Circle 23 on reader service card

Clever Kleps

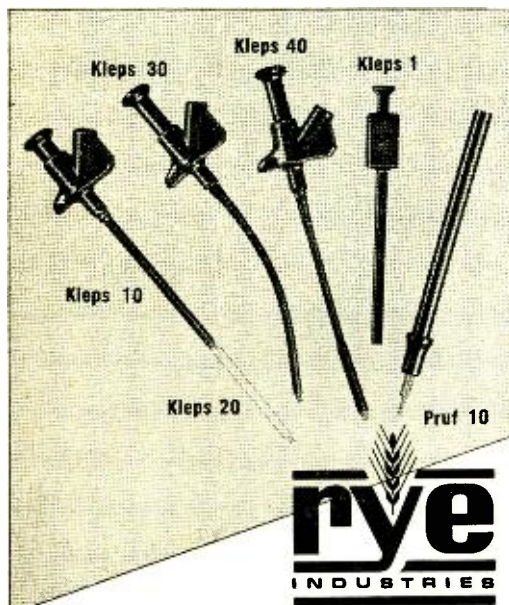

Test probes designed by your needs—
Push to seize, push to release (all Kleps spring loaded).

Kleps 10. Boathook type clarip grips wires, lugs, terminals. Accepts banana plug or bare wire lead. 4¾" long. **\$1.19**

Kleps 20. Same, but 7" long. **\$1.39**

Kleps 30. Completely flexible. Forked-tongue gripper. Accepts banana plug or bare lead. 6" long. **\$1.47**

Kleps 40. Completely flexible. 3-segment automatic collet firmly grips wire ends, PC-board terminals, connector pins. Accepts banana plug or plain wire. 6¾" long. **\$2.39**

Kleps 1. Economy Kleps for light line work (not lab quality). Meshing claws. 4½" long. **\$.99**

Prof 10. Versatile test prod. Solder connection. Molded phenolic. Doubles as scribing tool. "Bunch" pin fits banana jack. Phone tip. 5½" long. **\$.79**

All in red or black — specify.
For additional information, write for our complete catalog of — test probes, plugs, sockets, connectors, earphones, headsets, and miniature components.
Available through your local distributor, or write to:
RYE INDUSTRIES, INC.
127 Spencer Place, Mamaroneck, N.Y. 10543



IMPROVE SOUND RELAY

Mr. Wilson's sound-operated relay (September issue) was of special interest, since I have designed several of these in various forms over the past 10 years.

The circuit as shown is well-conceived. However, one suggestion may be of interest to your readers. I have found that an inexpensive magnetic earphone, of the type often supplied with miniature radios, makes a fine microphone for this application. Besides being cheaper and much smaller than a speaker, these tend to have a broad resonant peak in the frequency range of interest, which improves sensitivity. Further, their typical impedance of a few kilohms is ideal for matching most common transistor amplifiers.

For further miniaturization, the bistable relay may be replaced by a transistor flip-flop driving a standard miniature relay. I have built an entire circuit comfortably into a 2¾ x 2½ x 1½-inch Minibox. A chassis-mounting male ac plug on the Minibox makes the unit self-supporting when plugged into a wall outlet. Of course the case must be isolated from the circuit, and preferably connected to a third "ground" prong on the ac plug for hot chassis safety.

MAXWELL STRANGE
Fulton, Md.

VANISHING LETTERS

Some of the lettering for the PC pattern got trimmed from the margin in our "One-IC Radio" article last month (page 51).

R11-2 is the unlabeled lead between R11-3 and R11-1 on the left. On the right of the drawing, 1, 2 and 3 coming from S1/R11 are twisted leads going to respective points on the left. The left unlabeled wire is +6V to the PC pattern and the right unlabeled wire is +6V to B1.

If you're interested in obtaining AmpereX parts for the project, write: One-IC Radio, RADIO ELECTRONICS, 200 Park Ave. S., N.Y., N.Y. 10003

RADIO-ELECTRONICS

7 arguments in favor of building your own speaker system from scratch.

The easiest way to buy high fidelity speakers may not always be the best. Because a complete pre-packaged system may be far from what you need. Consider some of the advantages of separate component loudspeakers:

1. You choose from an almost infinite variety of sizes and levels of performance. Your system will exactly reflect your specific listening preferences.

2. You save space by building speakers into walls, ceilings, closet doors, even in floors! Or use existing cabinets or custom-built enclosures that better suit your decor than any mass-produced system.

3. You enhance the illusion of "live" music by hiding or disguising the sound source. You listen to the music — not the speakers.

4. You end the conflict between fine sound and handsome decor by making the speaker system an integral part of the room or the furniture.

5. You save money by paying only for performance.

6. You can up-date your component system as often as you wish to meet advances in the state of the art.

7. You can use the building-block method of planned improvement as your budget permits. There's no problem of

being "stuck" with a compact that fits today's budget but can't meet your ultimate listening goals.

Take a few minutes to study the variety of Electro-Voice component speakers. 21 models from \$14.00 to \$250.00. From super-tweeters to giant 30" woofers. Consider how they can aid in creating a speaker system that uniquely expresses your musical needs. And ask your Electro-Voice high fidelity specialist for his recommendation. Finally, take the time to listen carefully.

Freedom of choice. It's at the nub of high fidelity.

ELECTRO-VOICE, INC., Dept. 1294E,
613 Cecil Street, Buchanan, Michigan 49107

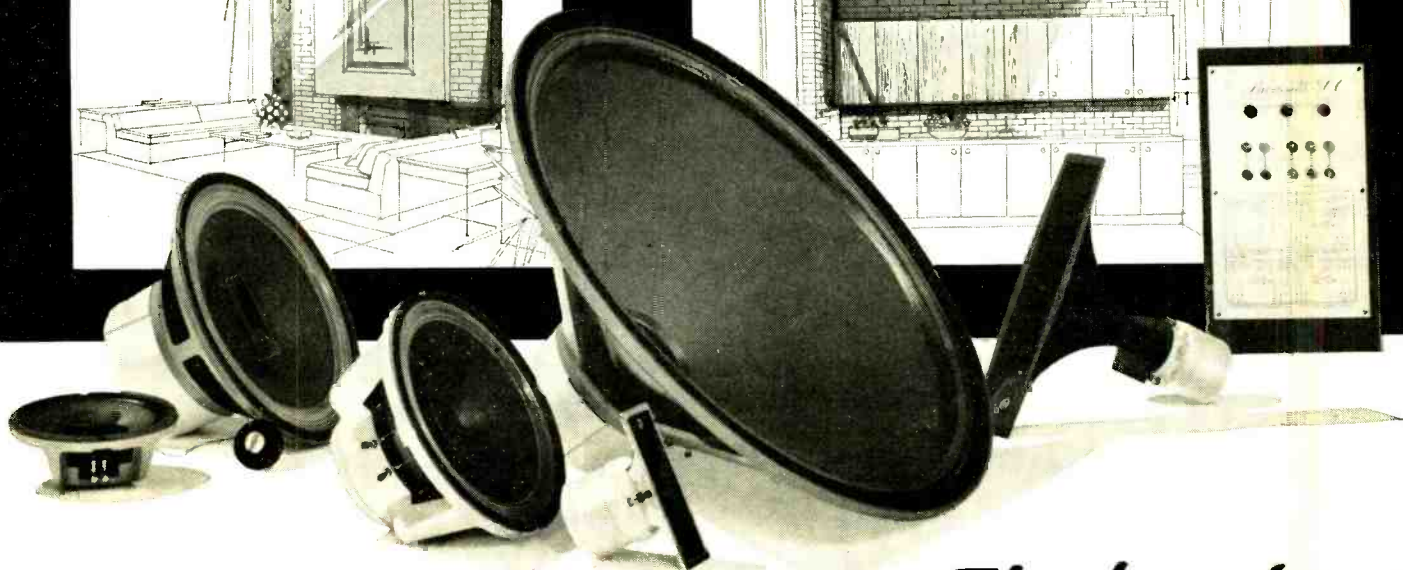
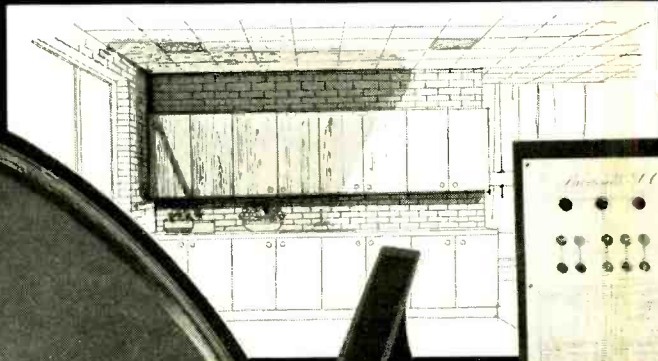
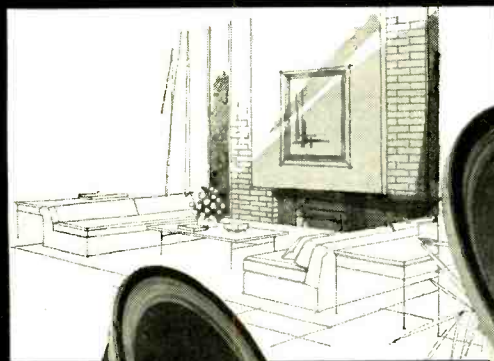
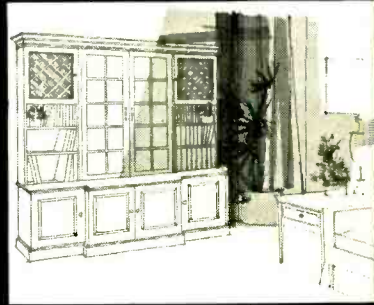
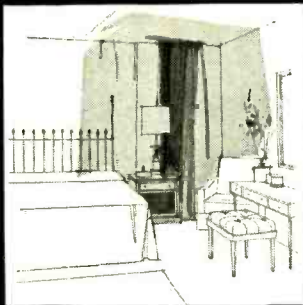
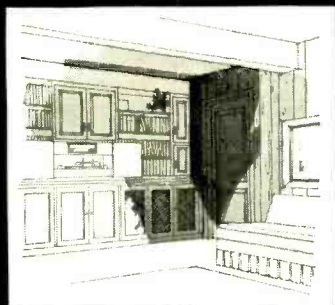

Electro-Voice®

A SUBSIDIARY OF GULTON INDUSTRIES, INC.

Circle 25 on reader service card

We pack your electronics course with kits to make your training fast. You'll enjoy every minute of it.



Your NTS success package

Choose a career in electronics: Computers. Color TV Servicing. Automation. Communications. Whatever the field, NTS has a complete home-study package to get you to the top *faster*. 10 thorough training courses. Each includes *everything* to give you the *working* knowledge required of successful technicians.

NTS Project-Method Training is the practical way to learn elec-

tronics. It's a proven combination of lessons and the best professional kit equipment available. NTS provides the *biggest selection of kits ever offered in home-study . . . all at no extra cost*. You'll construct these exciting kits to fully understand electronic circuits, components, and concepts. Our Project-Method lets you *build* skills by putting theory into practice . . . by working with your hands, as well as your head.

The NTS "learn and practice" approach makes training at home really easy. All it takes is a few hours a week . . . whether you're starting from scratch or in advanced courses. This is the all-inclusive success package that put thousands of men into the best paying jobs . . . or into their own business. If "just a living" isn't good enough for you, now is the time to get something better going for you!

NTS COMPUTER ELECTRONICS

This is the future. And it's happening now. The number of computers will *increase many times* in the next few years.

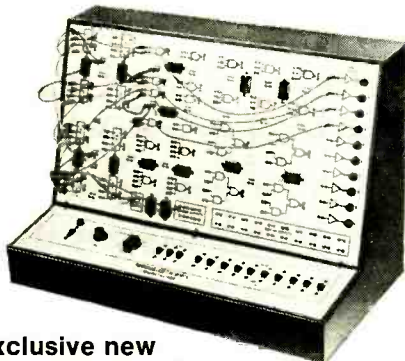

Exclusive new Compu-Trainer®

NTS offers a solid grounding in computer operation, wiring, data processing and programming. One of the 10 important kits included is our exclusive Compu-Trainer®. It's a fully operational computer logic trainer — loaded with integrated circuits — the first ever offered in home study. It introduces you quickly to how, what, when and why of computers . . . from theory to practical servicing techniques. This unit is capable of performing 50,000 operations per second. And it's sent at no extra cost.

NTS COLOR TV SERVICING

This is a broad, easily understood

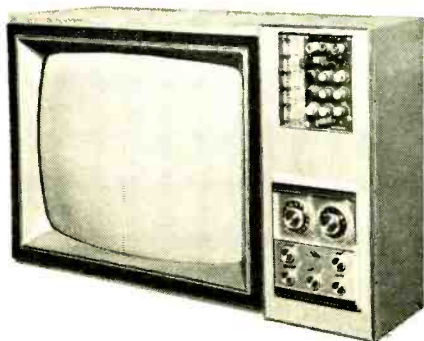

COLOR TV 295 SQ. IN. PICTURE

program designed to make you a complete home-entertainment service technician. Included, at no extra cost, is a color TV that has more features than any

set on the market. You also learn all about stereo, hi-fi, multiplex systems, and become a specialist in Color TV Servicing. Kits also include AM-SW radio, solid-state radio, field-effect transistor volt-ohmmeter, electronic tube tester.

NTS AUTOMATION/ INDUSTRIAL ELECTRONICS

You're trained in the "push-button" electronics that keep industry going and growing . . . from relay type controls to highly advanced systems essential to production. You receive 16 kits including a 5" wide band oscilloscope, and the new NTS exclusive experimental laboratory. A complete workshop which makes you familiar with solid-state, miniature, and integrated circuits.

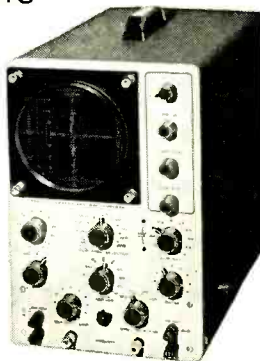

5"
Oscilloscope

NTS ELECTRONIC COMMUNICATIONS

The use of 2-way radio systems in private and commercial applications is skyrocketing. NTS prepares you for the big-money opportunities in the field of transmitting and receiving equipment. *Your tuition will be refunded in full if you cannot pass the FCC exam for a 1st Class Commercial Radio-Telephone License within*



5 Watt AM Transmitter & Receiver

six months after successfully completing this course. You build valuable kits including Amateur-Phone 6 Meter VHF Transceiver, solid-state Radio, and a field-effect transistor volt-ohmmeter.

CLASSROOM TRAINING AT LOS ANGELES

You can take classroom training at Los Angeles in sunny Southern California. NTS occupies a city block with over a million dollars in facilities devoted exclusively to technical training. Check box in coupon.

NATIONAL TECHNICAL SCHOOLS

World-Wide Training Since 1905

4000 South Figueroa Street
Los Angeles, Calif. 90037, U.S.A.

APPROVED FOR VETERANS

Accredited Member: National Association of Trade and Technical Schools, National Home Study Council.

**TODAY, MAIL
COUPON
FOR FREE
COLOR
CATALOG
AND SAMPLE
LESSON.**

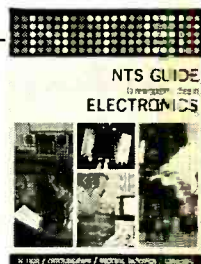

NATIONAL TECHNICAL SCHOOLS
4000 S. Figueroa St., Los Angeles, Calif. 90037

Please rush Free Color Catalog and Sample Lesson, plus information on field checked below. No obligation. No salesman will call.

- MASTER COURSE IN COLOR TV SERVICING
- COLOR TV SERVICING
- MASTER COURSE IN TV & RADIO SERVICING
- PRACTICAL TV & RADIO SERVICING
- MASTER COURSE IN ELECTRONIC COMMUNICATIONS
- FCC LICENSE COURSE
- MASTER COURSE IN ELECTRONICS TECHNOLOGY
- INDUSTRIAL AND AUTOMATION ELECTRONICS
- COMPUTER ELECTRONICS
- BASIC ELECTRONICS

Name _____ Age _____

Address _____

City _____ State _____ Zip _____

Check if interested in Veteran Training under new G.I. Bill.

Check if interested ONLY in Classroom Training at Los Angeles. Dept. 206-129

NEW from SINCLAIR-AUDIONICS

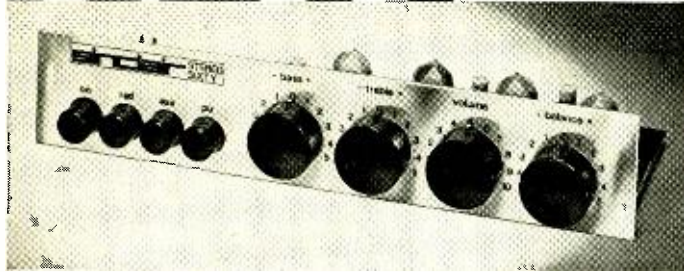

Stereo Sixty Control Center

The Sinclair Stereo 60 is a completely new unit for use with the new Z-30 amplifier module. Four push buttons are used for input selection and rotary controls are used for bass, treble, volume and balance. The on-off button also controls the power to the power amplifiers. The Stereo 60 may be used with two IC-10's or any other high performance amplifier. As with the Z-30, the Stereo 60 is unsurpassed in its price range.

STEREO 60 SPECIFICATIONS

Frequency response: Radio and Aux. 20-25KHz plus or minus one db. RIAA equalization accurate within one db.
 Inputs: Radio, auxiliary and magnetic.
 Overload factor: Better than 20db on all inputs per channel.
 Distortion: .03%.
 Signal-to-noise: Better than -70db unweighted.
 Size and finish: 8¼ x 1½ x 4 inches. Aluminum with black trim.



The new PZ-6 power supply unit is suitable for driving a pair of Z-30's and the Stereo 60. The PZ-6 is fully filtered and stabilized and provides 1.4 amps at 35 volts DC.

\$36.95

\$23.95

The Stereo 60, Z-30 and PZ-6 are recent additions to the expanding Sinclair-Audionics line of audio modules. The Z-12, IC-10, Stereo 25 and PZ-4 units are recommended where less power or ultimate performance is required.

To receive a brochure describing the entire Sinclair line ranging from the IC-10 silicon integrated circuit high fidelity amp and pre-amp to the teak-trimmed Q-16 speaker system, use the coupon below or a postcard and mail to Audionics, Inc., 9701 S.E. Mill, Portland, Oregon 97216.

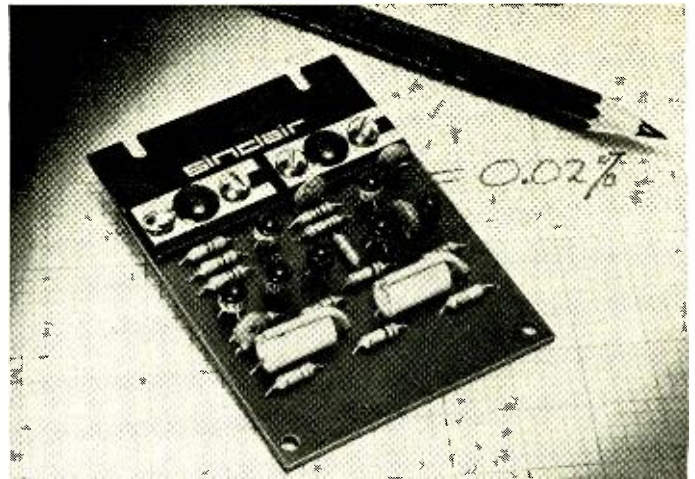

Z-30 Audio Amplifier Module

The introduction of the Z-30 high fidelity amplifier module by Sinclair now makes it possible to construct an amplifier with laboratory standards for less money than ever before. The Z-30 module boasts the lowest distortion level of ANY amplifier in the world. At the maximum rated output or any level lower than the maximum, the harmonic distortion never exceeds .02%. The Z-30 utilizes nine silicon epitaxial planar transistors in a unique circuit. Over 60 db of negative feedback, with a constant current load to the drive stage obtained by incorporating a two transistor circuit in place of the more usual bootstrapping technique, helps to achieve this remarkable performance. Besides home audio applications the Z-30 is ideal for many commercial and industrial uses where high performance, reliability and size are factors . . . not to mention low cost.

Z-30 SPECIFICATIONS

Power output: 15 watts continuous sine wave (30 watt peak) into 8 ohms from a 35 volt supply.
 25 watts continuous sine wave (50 watt peak) into 4 ohms from a 35 volt supply.
 Frequency response: 20 to over 30KHz plus or minus one db.
 Distortion: .02% or less up to and including full output into 8 ohms.
 Size: 3 x 2.2 x 0.5 inches.
 Sensitivity: 250mv into 100K ohms.
 Signal-to-noise: -70db unweighted, class AB output.
 Power requirements The Z-30 will perform perfectly down to voltages as low as 8vdc, with the exception that power output levels will be decreased.

\$17.95

All Sinclair-Audionics products are backed with our money-back guarantee. If you should be dissatisfied with any unit for any reason, return it unused immediately for full refund. All Sinclair constructor items are guaranteed by Sinclair for one year against failure due to manufacturing defects or poor workmanship. Dealers interested in learning more about the Sinclair-Audionics group of products should write to AUDIONICS, INC. for the name of the nearest representative.

Please allow 2 weeks for delivery.



SINCLAIR constructor audio modules available exclusively from AUDIONICS, INC. and selected dealers

sinclair

To: AUDIONICS, INC., Dept. RE-12, 9701 S.E. Mill, Portland, Oregon 97216
 PLEASE SEND POSTPAID

NAME _____	STATE _____	ZIP _____
ADDRESS _____		
CITY _____		

FREE Literature FOR WHICH I ENCLOSE CASH/CHECK/M.O.

Circle 29 on reader service card

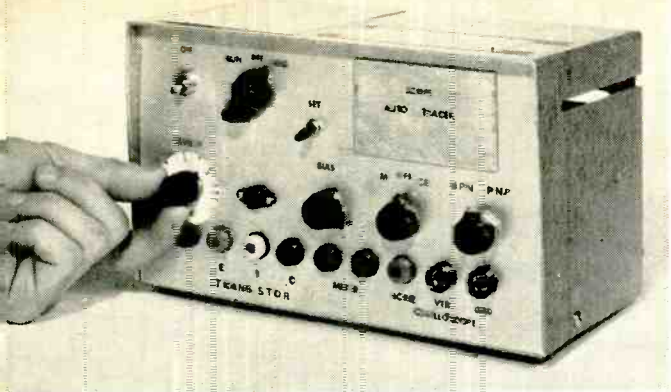

Automatic— TRANSISTOR CURVE TRACER

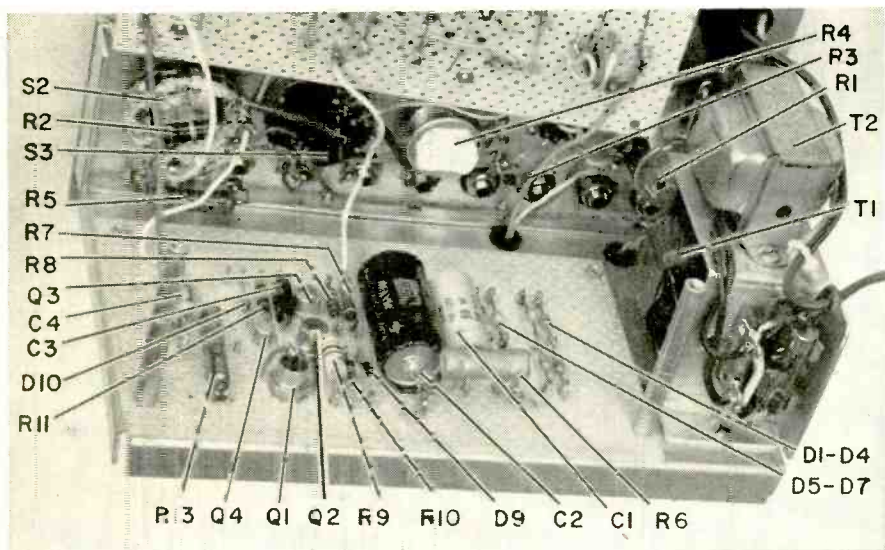

Parts layout for the filter/regulator circuit is shown in the photo above. The text describes details of the chassis arrangement used by the author. The photo below shows the perboard layout for the sync generator, counter and step bias circuits. *See text & parts list.

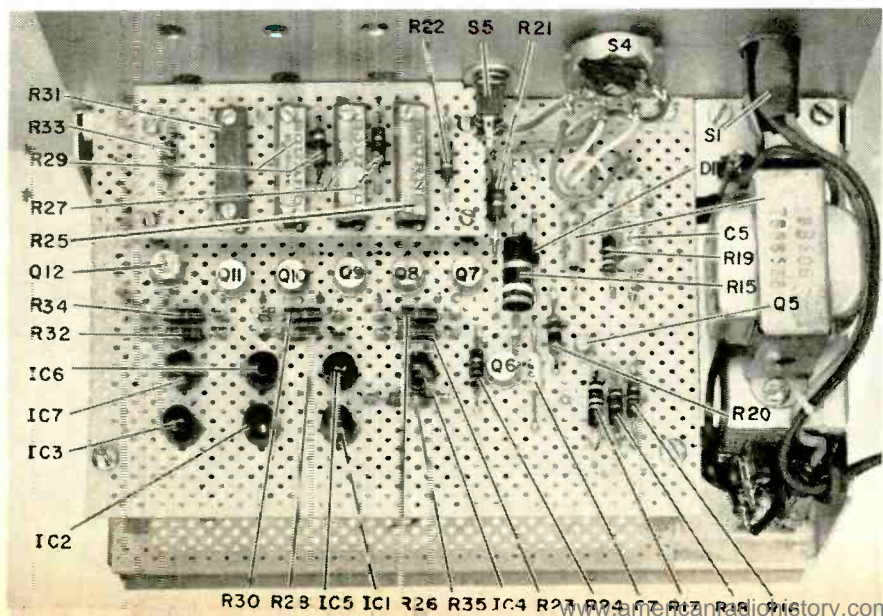

by PHILLIP C. BRASSINE

SCOPE-TRACE DIAGRAMS OF TRANSISTOR characteristics are familiar to most people working with solid-state electronics. Manuals and data sheets show selected transistor curves from which you can establish circuit parameters.

Often though, it's desirable to make sets of curves for particular transistors and to supplement available information. Comparisons between two or more transistors of the same type are often required for matching or selection. Familiarity with a scope tracer makes it easy to identify unmarked units as to type and voltage. Zeners and other diodes may also be tested.

The scope tracer described here will provide the more common and desirable transistor parameters. It was designed to place npn and pnp types in the common-emitter configuration and permit six curves to be displayed individually or simultaneously on the scope screen. Audio, rf, switching and some low-power units can be tested within a range of up to 1 mA or so of base current.

A basic tracer circuit

The basic circuit of a curve tracer is shown in Fig. 1. Rectified ac is applied across the collector and emitter of the test transistor. This voltage deflects the horizontal amplifiers of the scope. The voltage drop across the 100-ohm sensing resistor is proportional to the current flow through it and deflects the vertical amplifiers according to this ratio.

A battery and variable resistance form the base bias circuit. When R_b has infinite resistance, the collector and emitter can be considered an open circuit and the collector voltage will be maximum. When bias is applied to the base, current flows relative to the characteristics of the transistor, reducing V_{CE} accordingly.

The amount of bias is shown on the CRT by the height of the sweep voltage above the base line. The length of the trace depends on the value of the sweep voltage relative to the applied bias. In light of transistor action: as base current increases, the collector-to-emitter voltage decreases until the transistor reaches saturation.

To obtain a satisfactory reference point (base line) for the curves, the dc input of the scope is used. The grid of the CRT is usually defined in peak-to-peak volts per major division. The vertical displacement is converted to mA according to the IR drop across the sensing resistor.

If a number of different biases are applied, a like number of curves are produced, and the total is considered a family of curves from which

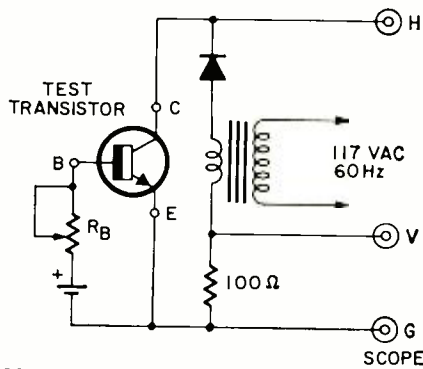

Fig. 1—Simple test circuit applies rectified ac across collector and emitter.

the characteristics of the transistor can be computed. Of necessity, each curve must be copied onto graph paper for evaluation. If all curves can be seen simultaneously, only the pertinent data need be recorded in most instances.

Auto tracer circuit

A combined block diagram and schematic of the scope tracer circuit is shown in Fig. 2. No chassis ground is used as both supplies must be reversed to accommodate the two types of transistors.

Transformer T2 supplies full-wave rectified voltage between the collector and emitter of the test transistor. This voltage is controlled by the 3000-ohm pot. Limiting resistor R2 restricts the current to about 100 mA to safeguard precision resistor R5. Transformer T1 feeds a full-wave supply that furnishes power for all units in the base circuit.

Six transistors shunt the bias line of the test transistor to obtain different voltage levels. The bias steps are controlled by the counter, which is driven by the sync generator. An external meter is connected into the bias line to set specific biases.

With pnp transistors, the curves are displayed conventionally: left to right for sweep voltages, and bottom to top for vertical deflection. Npn curves are reversed and upside down. Either presentation is satisfactory after you are accustomed to working with them.

The unijunction transistor sync generator in Fig. 3 is supplied from the positive side of the rectified output of T1. Bias of UJT Q5 is established by R18 and R20 relative to R16. Resistor R17 and a capacitor across the emitter of the UJT form the timing network for the sawtooth wave. The firing point of the UJT is synchronized to occur on the negative slope of the waveform seen at B2. The output pulses from B1 are inverted by Q6 and used to drive the counter flip-flops.

Although it is a simple matter to obtain synchronization with the source voltage, the bias steps must occur at the zero phase angle of the sweep voltage; otherwise, lines or breaks will appear on the horizontal section of the curves. Final selection of UJT circuit resistors should therefore be done only after the tracer can produce scope traces.

With S4 at RUN, the generator operates at a 120-Hz rate. In TRIG,

this is slowed to about 1 sec by C6. The switch is turned from TRIG to OFF to retain any bias curve. A resistor in the OFF position reduces the emitter potential well below the firing point to introduce a time delay when the switch is returned to TRIG. This delay prevents premature triggering of the counter by switch contact.

The counter is a conventional divide-by-six circuit composed of three IC flip-flops (IC1-IC3). These are decoded by four dual 2-input gates (IC4-IC7) to give six outputs, each connected to a transistor that shunts the bias line through a variable resistance.

Decoding is accomplished by two or more lows from the flip-flop outputs to cause a high level at one of the gate outputs. These operate in a sequential manner in which only one is high at any time. Decoding operation is illustrated in the truth table. The high level biases the respective transistor to conduction, while the resistance of the pot determines the shunting action, setting the voltage to a specific level.

A 500-ohm resistor in the regulator supply line to the bias circuit limits the maximum current. The step-bias circuit is therefore equivalent to six combined shunt-voltage regulators, each on for 8.33 msec at a 20-Hz rate.

SET toggle switch S5 is used when S4 is at RUN only. This toggle switch permits setting and measuring the maximum bias applied to the test transistor without recourse to triggering. When S5 is closed, the counter will continue operating until IC7 (pin 6) goes high. The connection to the clear input (pin 3) of IC1 holds the NOT-A output in a high state, preventing further action. A and C of the divider are low at this time, so trace 6 is presented until S5 is opened.

The driver transistors should be tested for complete switch action. That is, that they turn on and off completely. This will insure minimum interaction between these elements. If necessary, the bias resistors can be adjusted to compensate for differences in gain.

If difficulties are encountered with the IC circuit, the driver collectors can be disconnected from the resistances and 10-volt 15-mA or similar lamps inserted to give a visual display of counter action. In this case the lamps are connected directly to the 10-volt line and the slow speed of the sync generator is used.

Regulated supply

A highly regulated supply is included in the tracer (Fig. 4). It will

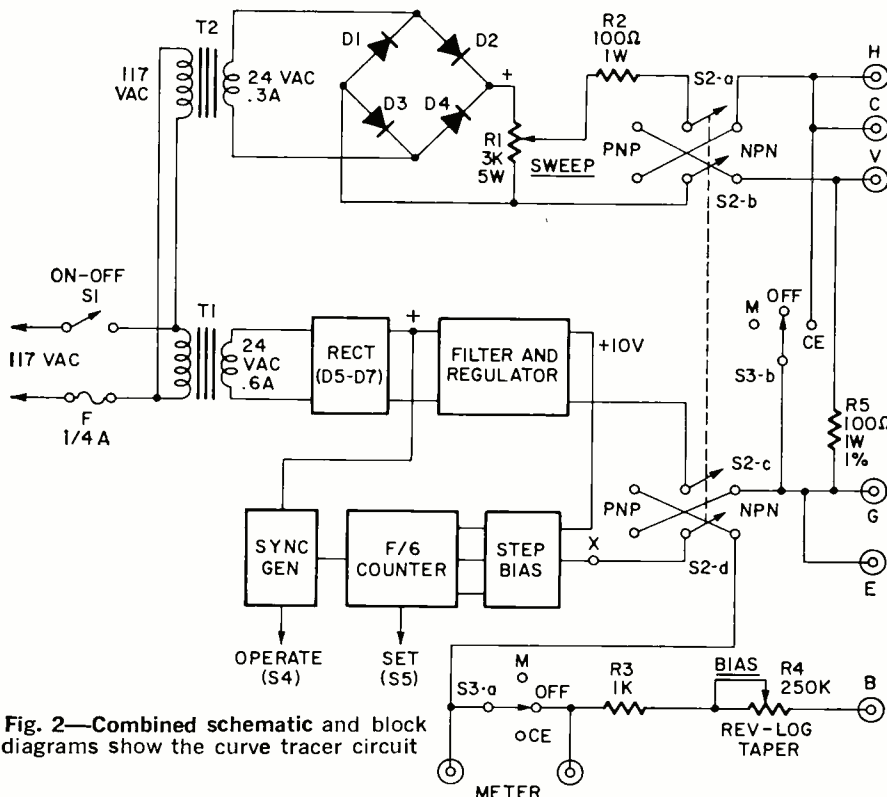

Fig. 2—Combined schematic and block diagrams show the curve tracer circuit

hold a constant +10 volts from no load to the full load of 160 mA. Output ripple is less than 2 mV. The step bias is supplied directly from the 10-volt line while the IC circuit voltage is reduced to 3.6 volts by a current-limiting resistor and Zener diode.

The first filter capacitor from the rectifiers is small to provide a waveform with sufficient amplitude to which Q5 can be synchronized.

The resistance value from the emitter of Q3 to ground must be determined during tests covering no-

load to full-load conditions. Too low a value can cause positive regulation (a slight rise in voltage with increased current), so R8 should be fixed just above this point.

A 5000-ohm trimmer can be substituted for the three-element divider network (R12, R13, R14) to the reference amplifier. Other transistors can be used in this circuit with equal results. A 2N1613 can directly replace the 40407 shown in the diagram.

In the step-bias circuit of Fig. 3 resistors R22 and R33 for curves 1

and 6 are fixed values, although they can be made adjustable if preferred. Resistor R22 places the lower curve near the base line for most transistors. Resistor R33 is set for about 3 mA through the driver when it is conducting. The resistances of R25, R27, R29 and R31 are approximate values and will vary somewhat according to operating conditions.

A preliminary adjustment of the pots is made by shorting the B-E terminals, triggering for curve 6 and setting R_B (BIAS pot R4) for 100 μA, using a microammeter in the jacks

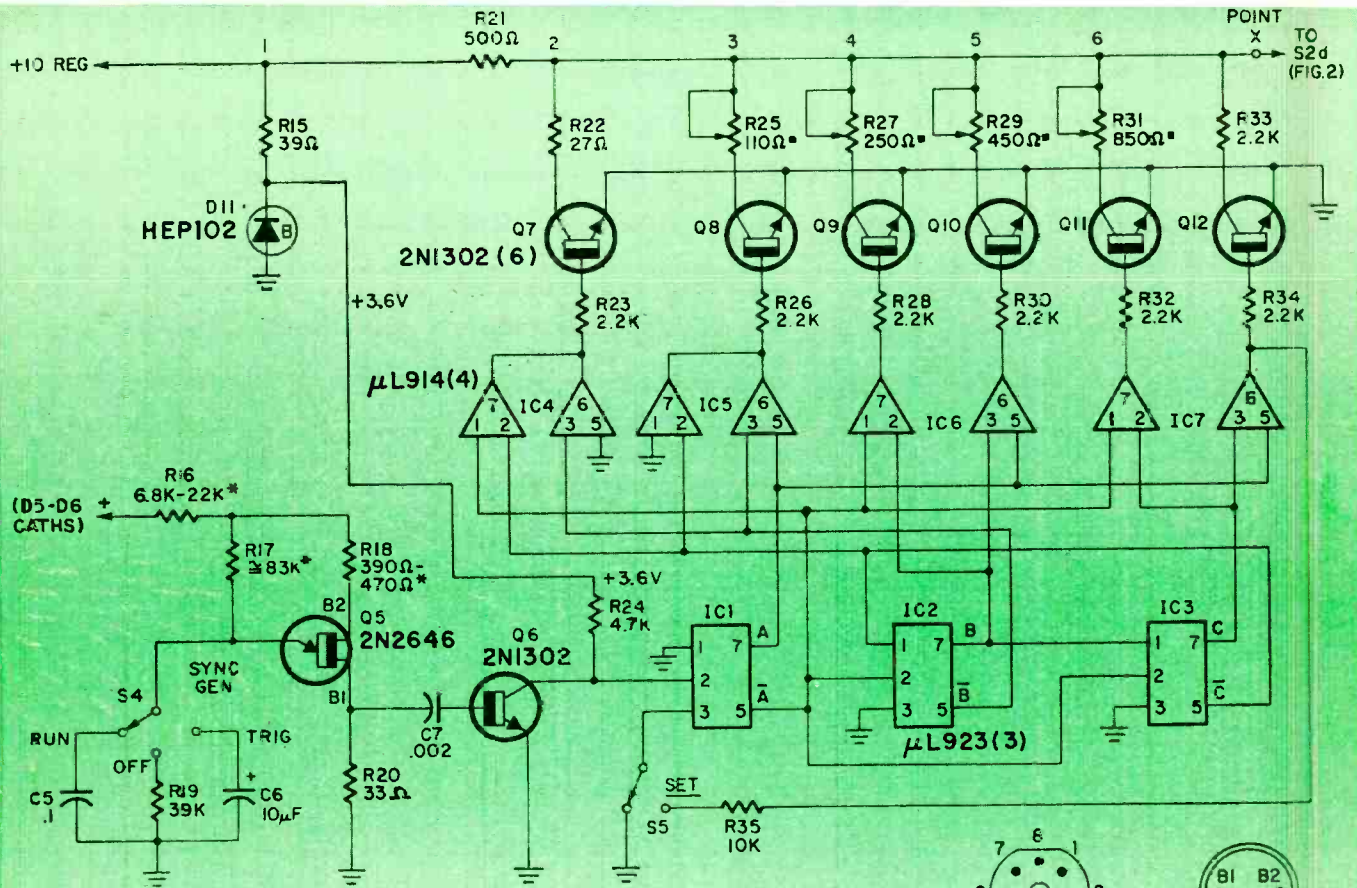
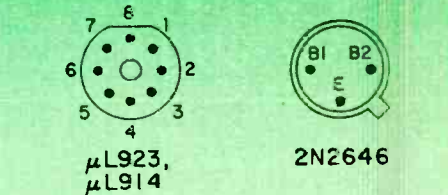

Fig. 3—Sync generator circuit includes (Q5), counter (IC-1 IC3) and decoders (IC4-IC7), which provide step bias through transistors Q7-Q12.

- PARTS LIST (Figs. 2, 3 and 4)**
- R1—3000-ohm, 5W, wirewound linear potentiometer
 - R2—100-ohm, 1W
 - R3—1000-ohm
 - R4—250,000-ohm, reverse-log (CCW)-taper potentiometer
 - R5—100-ohm, 1W, 1%
 - R6—65-ohm, 5W
 - R7, R24—4700-ohm
 - R8—680,000-ohm (see text)
 - R9—27-ohm, 1W
 - R10, R11, R35—10,000-ohm
 - R12—1500-ohm
 - R13—5000-ohm trimmer potentiometer
 - R14—2700-ohm
 - R15—39-ohm, 2W
 - R16—6800—22,000-ohm (see text)
 - R17—83,000 ohms
 - R18—390—470 ohms (see text)
 - R19—39,000 ohms
 - R20—33 ohms
 - R21—500 ohms (2 1,000-ohm, 1/2 W in parallel)

- NOTE: GROUND TO REGULATOR ONLY**
- IC1-IC7: PIN 8 - +3.6
PIN 4 - GROUND
- *SEE TEXT
- APPROX SETTING, SEE PARTS LIST, TEXT
 - R22—27 ohms
 - R23, R26, R28, R30, R32, R33, R34—2200 ohms
 - R25, R27—500-ohm trimmer potentiometer (150-ohm series resistor with R27)
 - R29—1000-ohm trimmer potentiometer (with 220-ohm series resistor)
 - R31—2000-ohm trimmer potentiometer
 - All resistors 1/2 watt, 10%, except base resistors for Q7-Q12, (5%).
- Capacitors**
- C1—50 μF, 50V, electrolytic
 - C2—250 μF, 50V, electrolytic
 - C3—0.01 μF
 - C4—10 μF, 15V, electrolytic
 - C5—0.1 μF, 100V
 - C6—10 μF, 15V, electrolytic
- Semiconductors**
- D1-D8—1 amp, 100 PIV or more diode
 - D9, D10—6.2-volt, 1W Zener diode (HEP 103 or equal)
 - D11—3.6-volt, 1W Zener diode (HEP 102 or equal)



- Q1—Any 500-mA, npn power transistor (see Radio Shack No. 276-587, '69 catalog). (2N1647 is stud mount to fit space)
 - Q2—40407 transistor (RCA)
 - Q3—2N1305 transistor (RCA)
 - Q4—2N40231 transistor (RCA)
 - Q5—2N2646 unijunction transistor (GE)
 - Q6-Q12—2N1302 transistor (RCA)
 - IC1-IC3—μL923 JK flip-flop integrated circuit
 - IC4-IC7—μL914 dual 2-input NAND/NOR gate integrated circuit
- Other parts**
- S1—spst switch
 - S2—4-pole, 2-position switch
 - S3—4-pole, 3-position switch
 - S4—sp-3-position selector switch (Centralab 1461 or equal)
 - S5—spdt toggle switch
 - T1, T2—24-volt, 300-mA and 600-mA transformers [Lafayette No. 99 TE266 (1A) is suitable for both]
 - MISC—Chassis, case, 1/4A fuses, fuse holder, knobs, jacks, IC sockets, perf board

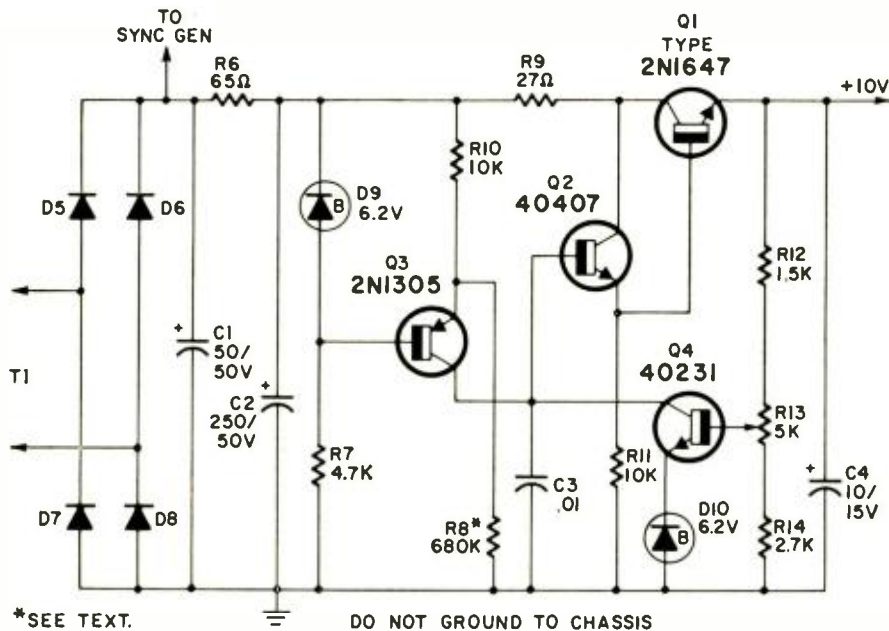

Fig. 4—Regulated supply circuit for the tracer keeps ripple to less than 2 mV. A Zener diode (D11 in Fig. 3) supplies the 3.6 volts for the integrated circuits.

provided. Biases of curves 2 through 5 are then set to 20, 40, 60 and 80 μ A, respectively.

The B-E terminals are now opened, a transistor inserted in the socket and the above procedure repeated. Polarity must be observed in all cases.

Since these even ratios will hold to about 1 mA of base current, it is only necessary to obtain curve 6 and mentally calculate the others. Each bias step can be checked by utilizing the TRIG position of S1 and allowing the counter to cycle, presuming meter response is adequate. Manual triggering (switching S4 back and forth between OFF and TRIG) can, of course, be employed when precise bias values are desired.

These even multiple ratios will generally hold true for either silicon or germanium transistors, but not both. The difference in the spread of their base resistance is most apparent at the lowest bias level, the silicon giving the lowest reading.

This difference may amount to 12, 8 and 6 μ A, for traces 1, 2 and 3, respectively, when trace 6 is set for 100 μ A. Ordinarily trace 1 can be used as an indicator and left to fall as it will. The pots can be set to a mean value so the percentage of error will be within tolerable limits for most calculations. Therefore, quick evaluations can be made by merely utilizing S5 and setting R4 to some value.

Since interpretation of transistor characteristic curves is described in many books, only a few points will be discussed here. For detailed analysis, a photo or graph reproduction

of the display may have to be made. Load lines can be derived directly from the curves. A diagonal is placed from a point on the I_c ordinate to a point on the V_{ce} axis. This gives $R_L = V_{ce}/I_c$.

Dc beta = I_c/I_b . A vertical line is drawn from V_{ce} to intercept a curve having a certain base current. From this point on the curve a line is projected to the I_c ordinate. Beta is then a ratio of the base current to the collector current at a specified collector voltage.

Transistor saturation is termed the region to the left of the knee of the curve and is defined as $V_{ce(sat)}$ at some stated I_c and I_b . The point at which the transistor reaches saturation can also be found by displaying curve 6 and increasing I_b until the end point of the curve becomes coincident with the vertical section. At this point any further increase of I_b will cause little increase in I_c .

Zener diode characteristics are found with these two operations: If the polarity is known, connect the cathode to the collector, and the anode to the emitter of the transistor socket (R_b is not used.) The tracer is hooked to the scope as when displaying curves. The scope horizontal gain is set to a convenient value such as 2V/cm. The tracer NPN mode places a positive voltage on the cathode, and increasing the tracer sweep displays the breakdown voltage. Changing to the PNP mode reverses the current through the zener, and the forward conduction curve will be seen. The scope horizontal gain can be changed to 1 V/cm for a more accurate reading.

Diodes and rectifiers are displayed in the latter manner. Minimum sweep is used to prevent overheating from excessive current. Double lines can be caused by several factors and may not always be possible to eliminate. If the problem is serious, check the amplitude of the complementary half sine waves from the rectifier output. Transformer T2's secondary may be unbalanced; causing a difference in the two half cycles. They should be reasonably close. Keep all wiring capacitances to a minimum. Excessive tracer sweep voltage combined with high bias and high vertical scope sensitivity will aggravate the condition. Be sure to use the dc input to the scope. Observation of the waveforms generated in the tracer will aid in adjusting and troubleshooting. The pertinent voltages are:

Diodes and rectifiers are displayed in the latter manner. Minimum sweep is used to prevent overheating from excessive current.

Double lines can be caused by several factors and may not always be possible to eliminate. If the problem is serious, check the amplitude of the complementary half sine waves from the rectifier output. Transformer T2's secondary may be unbalanced; causing a difference in the two half cycles. They should be reasonably close. Keep all wiring capacitances to a minimum. Excessive tracer sweep voltage combined with high bias and high vertical scope sensitivity will aggravate the condition. Be sure to use the dc input to the scope.

Observation of the waveforms generated in the tracer will aid in adjusting and troubleshooting. The pertinent voltages are:

UJT sync	UJT-B2	Lower half of negative slope
UJT sawtooth	UJT-E	3-9V p-p 120 Hz
UJT output	UJT-B1	1-4V p-p positive pulse
Counter input	Q6-C	0.8V p-p negative pulse
Gate outputs	1C4-1C7	3V p-p 20 Hz
Step biases	Point X	5-6V p-p overall Equal steps of minimum tilt
VE curves	Vertical jack	Six curves

The VE curves are formed across the sensing resistor with a transistor in the tracer socket and step biases applied. (Use scope internal sync.) Place a pot across R16 or R17 of the UJT sync generator. Note the effect a decrease in resistance has on the curves. Both points of each curve should stop on the same horizontal level, without breaks or overshoots.

Scope calibration

An audio oscillator and vtm are used to calibrate the scope. Since the vertical gain on some scopes is not calibrated, the complete procedure will be described.

A sine-wave signal with a frequency of 120 Hz and amplitude of 2 volts p-p as measured by the vtm is fed to the vertical input of the scope. The vertical attenuator and gain control are adjusted for a 4-cm
(continued on page 77)

TRUTH TABLE

Sequence	A	B	C	\bar{A}	\bar{B}	\bar{C}
1				L	L	L
2	L				L	L
3		L		L		
4	L	L				
5			L	L		
6	L		L			



New in stereo Cassettes '70

The boom in the cassette field continues to grow as 'gimmicks' and 'gadgets' make listening easy, and high-quality tapes improve the sound

by **WALTER G. SALM**

USE ANY YARDSTICK YOU WANT TO—THE CASSETTE IS ONE of the fastest growing branches of the home entertainment industry. These days the cassette has an undeniable identity—it's an all-purpose recording medium with almost universal public acceptance.

No one is afraid to buy a tape recorder now. The era of the all-thumbs-set being shut out of this market has passed. For the cassette is a tape medium that's human-engineered as no other recording system has been—right from the basic concept of a goof-proof plastic case enclosing a 1/4-inch-wide ribbon of tape—to snap-out anti-erase tabs that make accidental erasures a thing of the past.

Cassette players are priced as low as \$19.95 and four-song micro-cassettes are available at mini-prices (about 50¢ per song) making both the player and tapes competitive with both Playtape and records.

The cassette format is the only tape system that offers full compatibility and interchangeability between mono and stereo machines. Equipment includes mono players at \$19.95, mono 1/2-track recorders at \$29.95 up, stereo recorder/players for the living room starting at \$99, under-the-dash automotive stereo systems with recording capability for \$79.95, plus a new line of cassette plug-in AM and FM tuners. The cassette story is a bit much to absorb in just one gulp, so let's backtrack a little.

The first cassette—where it began

About six years ago, N. V. Philips Gloeilampenfabrieken, headquartered in Eindhoven, Netherlands, introduced the cassette recorder to the United States under its North American brand name, Norelco. The new machine was small, lightweight, and could be carried suspended from a shoulder strap. It used an enclosed plastic cassette-type cartridge that snapped in and out of the machine easily. The machine, dubbed the "Carry-Corder" had (and still has) a single-lever control for record/playback, fast forward and fast rewind. A small dynamic microphone and remote control switch fit easily

into a small leather case on the shoulder strap. The whole rig sold for \$150.

Then the idea took hold. Philips couldn't make Carry-Corders fast enough to keep up with the demand. A few copycat recorders showed up on the market very briefly—notable among these were machines from Grundig and Aiwa—both using different, non-compatible cassettes. The public started to get confused. Too many different types of "ideal" cartridges around. Which one to buy? The smart money was on Philips, and in a brilliant move that's still the cause of some debate, the Dutchmen offered to license the cassette format to any and all comers. They had 39 major companies signed up within a couple of months, and over the intervening years have managed to add just about every major recorder manufacturer in the world to the roster.

Today, the minuscule cassette is a major force in the recording industry. To be sure, the slow speed (1 7/8 ips) still limits upper frequency response, but this barrier too, is being pushed back. Right now, the lid seems to be between 10,000 and 12,000 Hertz.

It's in the prerecorded tape area that cassettes are having their greatest impact right now. Since the format lends itself so well to the teenage market, tape manufacturers such as Ampex are slanting entire product lines toward this audience. Hard rock and Top-40 tunes appear regularly in the \$1.98 micro-cassettes, and attractive sales promotion campaigns and deals are common.

Philips helped kick the bottom out of the market when it introduced a play-only machine last year for \$29.95. This is the same machine that's sold for the same price by Ampex and by Bell & Howell. The bulk of the cassette equipment from these two companies comes from the Philips lightbulb factory, produced either in Holland or in Austria. Heavily tape-oriented 3M was also name-branding Philips cassette machines for quite a while, but finally came out with its own line last year.

The Japanese manufacturers are probably the hardest to track down. Aside from the super giants like Sony, Panasonic (Matsushita) and Toshiba, most Oriental pro-

ducers gladly remain anonymous by private-labeling their products for as many retail outlets as want this service. Trade magazines abound with ads offering blank tape cassettes with "your company name here" on the paper label. Bargain hunters can find blank cassettes in dozen lots at incredibly low prices in the Sunday N. Y. Times sports section.

But such bargain hunting raises another potential problem—how good are the cheapie cassettes? The answer: pretty darn good—now. Twasn't always so. Couple of years ago, an inexpensive Japanese-made cassette could be expected to jam up or lose its trapped mylar leader after a couple of passes through the recorder. Even today,

Cassettes held together by screws are easiest to repair. Finger points to older type 3M cassette with Phillips screw. Newer cassette (foreground) has slotted bolts and nuts.

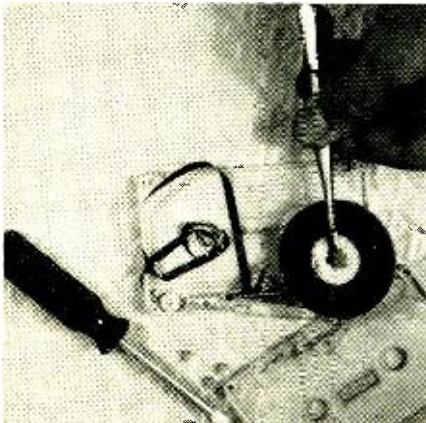

Lift out the tape and hub carefully with tweezers to keep that wispy ribbon from unraveling. Note tape is twisted around other hub. This portion of tape is damaged and will have to be removed.

Use ordinary splicing tape for this not-so-ordinary splicing job. Here, the transparent leader is scissor-spliced onto tape, then given "Gibson Girl" trim.



Laying that thin ribbon back in the guides is ticklish, demands tweezers, and shouldn't be hurried.

this can happen, and it does just as frequently with the expensive name-brand cassettes as it does with the cheap ones. It's possible to make repairs in most cases, provided you have the willingness, the patience, a steady hand and are loath to part with money needlessly.

When the cassette jams—fix it yourself

Before getting to the plan of attack, note that there are two basic types of cassettes—those held together with microscopically small Phillips (naturally) screws and those that are heat-sealed. Both types can be repaired. The ones held together with screws are the easiest. Just remove the screws and the two halves of the cassette come apart like two slices of bread peeled apart from a sandwich. It's the liverwurst in this sandwich that's important. It could be tangled around one of the hubs. The fragile ribbon of tape could have slipped out of its guides. Or perhaps the trapped leader (or trailer) has pulled out of the clamp that's supposed to hold it securely in place on the hub. Any of these problems can be fixed by obvious and nerve-wracking repairs that will try your patience. Be careful about one thing in particular—don't let that hub full of tape roll off the table. If this happens, you're likely to chuck the whole business and go back to an Edison phonograph.

Let's assume you've got the tape mended, placed nicely back in its guides (with tweezers, please), and the felt pressure pad assembly is laid gently in place. Now comes the aggravating job of mating the second slice of bread exactly to the tape, pressure pads, hubs and plastic alignment posts. Gently, gently, and just as you snap it into place, "Boing" goes the spring brass clip behind the pressure pads, some tape unravels, you curse a few times (or pound the table and weep—whichever is your forte), and start all over again. Don't despair; it *can* be done.

Now for the cassettes that are heat-sealed. There are two variations: one is simply heat-sealed; the other has a single Phillips screw in the geometric center, apparently to hold the whole shabang together when the heat treatment was applied. Remove that cotton-pickin' screw first. Then with a sharp penknife, pry the crack in the plastic open all the way around. Circumnavigate that cassette with your knife blade several times, each time biting a little deeper into the cassette. Eventually, you'll hear a satisfying "crack" as the blade breaks the heat seal once and for all. Crack the seal all the way around and the two slices of bread will peel off this sandwich neat as can be. After the repairs have been done, reseal the cassette with ordinary cellophane tape—Scotch "magic mending" tape is most suitable since it hides its presence by disappearing, and wears well in normal use.

Cassettes for your car are here

One of the nicest features of cassettes which you'll discover—especially with a unit installed in your car—is that you can roll your own. Unlike the 8-track cartridges, you can tape off the air, from your records or prerecorded open-reel tapes, or from the telephone. This last method can give you a nice side benefit. Ever try to find a strange place with a long list of complicated directions on a sheet of paper you can't read because you're busy driving? Next time you're faced with this prospect, hook up that cassette recorder to the telephone, and let your friend gab away, giving you all those "important" landmarks that you wouldn't bother to write down. Then replay that cassette in your under-the-dash machine or in a portable on the front seat. You've got perfect, detailed directions from the horse's mouth without taking your eyes off the road.

Trouble with those under-the-dash cassette recorders is most of them aren't theft-proof. About the only way

to debuglarize them is to use a miniature unit and keep it locked in the glove compartment. To play it, plop the unit on the front seat. Hopefully, some auto manufacturers will start to offer cassette options in new cars soon. Trouble is, nobody is quite certain just what has been committed by whom and to whom in the way of 8-track contracts. Time will tell.

Gimmicks and gadgets

Gadgets have a habit of cropping up whenever there's a successful product, and cassettes are no exceptions. Philips introduced a cassette changer a couple of years back, and this is now being handled by the usual Norelco outlets—including Ampex and Bell & Howell (below). This lets you stack up to six cassettes for longer playing periods. It retails for \$130 and is available in a deck version only.

The changer is in a way a stopgap measure—a hedge against the day when the auto-reversing cassette machine will bow. Such a unit may not be far off. At least one manufacturer (Nortronics) has licked the ticklish head design problem. The cassette is designed to admit only

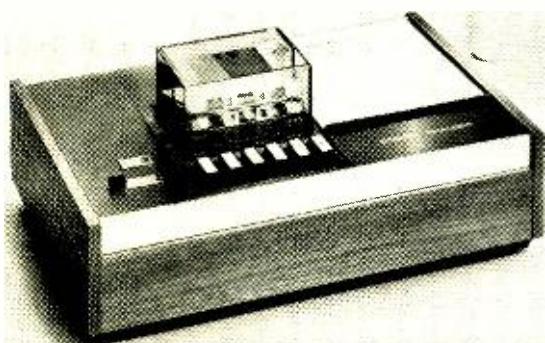

Bell & Howell automatic changer provides several hours of interruption-free music.

two heads—the erase and the combination record/playback. It has two holes for the heads, so each of these holes must have a three way, all-purpose head in auto-reversing machines. Triggering the reverse mechanism is easy—all cassettes have trapped trailers and leaders. All the machine needs is a tension-sensing trigger. The heads are here now. The machines are sure to follow soon.

Bell & Howell has come up with an unusual and highly appealing movie soundtrack system using a cassette recorder and a Super-8 camera and projector. All three elements must be purchased for the system to work. The photographer carries the cassette recorder which is plugged into the camera. When the camera runs, so does the recorder. So far so good. But here's the difference: the recorder makes two recordings—something like two-track stereo—one mono sound track plus a sync-control track. The sync track has a series of audio spikes on it and these spikes sync the recorder with the projector during playback. One still-unanswered question—how do you edit the movie?

Chromium dioxide to the rescue

Some cassette enthusiasts point gleefully to chromium dioxide tape (DuPont's "Crolyn") as the panacea that's going to give slow-speed cassettes true high-fidelity response at long last. True, Crolyn tape does increase frequency response—actually doubling it (or adding an octave if you prefer) over conventional iron oxide tape. This has been borne out by experiences at Crown International—a firm specializing in quality professional recorders made in U.S.A. plus a line of consumer-priced consumer-type tape gear made in Japan. Some of Crown's pro recorders feature front-panel-adjustable recording bias, a feature

that makes the switch to Crolyn tape rather painless. You see, Crolyn requires a different recording bias than the usual used for iron oxide. Strictly speaking, every different iron oxide formulation needs some bias optimization, but that's another story.

Crown proudly plays Crolyn tape recordings at 1-7/8 ips that certainly sound every bit as good as iron oxide tapes made at 3-3/4 ips and even some 7-1/2 ips tapes. But Crolyn is not ubiquitous material. DuPont has manufactured it only in instrumentation-grade, with some of it slit to 1/4-inch width. This has been for test purposes only, being sold on a limited basis for something like \$10 per 1200-foot reel (in quantity).

Crolyn has a serious disadvantage that will keep it out of your cassettes for some time yet—it's highly abrasive to recording (and playback) heads. Once this problem is licked, the mass tape duplicators can start to use it in prerecorded cassettes. So far, DuPont has licensed Memorex, Sony and Philips (naturally) to manufacture this tape. More may be coming, but these three seem to cover the international marketplace pretty thoroughly.

In another new tape development, Tokyo-based TDK Electronics Co., Ltd. has released significant cassette products. One is an extended-frequency-range tape with claimed frequency response from 30 to 20,000 Hertz. According to the firm's own response curve, the tape is flat from about 70 to 10,000 Hz. At 30 Hz, it's down about 6 dB, and it's down roughly 4 dB at 20 kHz. So much for the charts.

In actual practice, the sound was unbelievable. I tested a prerecorded demo cassette, and soon discarded it as too artificial sounding. Then I dubbed a London Phase 4 tape made with Dolby masters (Stokowski's performance of Night on Bald Mountain). This was admittedly playing dirty pool, since this London tape has about as many wide swings in dynamic range, and individually spotted special effects as any I've ever heard. Then I synchronized the original 7-1/2-ips reel tape and the dubbed cassette and A-B'd them.

Astounding point number one: the curve doesn't lie! The dubbed cassette sounded incredibly good. Granted, it lacked much of the dynamic range of the original, and tended to get muddy in sections where there were lots of loud transients, but by and large, an excellent job for a cassette.

TDK pulls off this feat by using a significantly smaller magnetic domain size than normal—about 0.4 micron long compared to the usual 1.0-micron domain length. This has roughly the same effect as doubling the tape-to-head speed, so presumably we're getting something like 3-3/4 ips instead of 1-7/8 ips. Still, the cassette has the usual limitations of its 1-7/8-inch speed—mainly wow and flutter. Yet, these were not serious in the test recording, in fact were hardly noticeable. No, it's not nearly as good as the Phase 4 original, but it's certainly the equivalent of lots of prerecorded open-reel tapes currently on the market.

The other innovation from TDK—one that wasn't ready for testing at press time—was an endless-loop cassette. Presumably this tape is super-lubricated as all endless cartridges must be. And presumably it will be beset by the same problems of wow and lubricant rubbing off onto the heads. But it suggests itself immediately for use in certain commercial sound applications, for stores, telephone answering equipment and other compact uses.

But what about right now, you want to know. Okay. Buy a \$20 player for your kids; get yourself a \$50-60 mono recorder for general-purpose use; buy a stereo deck that you can add to your living-room rig for \$99; buy a stereo unit for the car for \$79; buy a bunch of prerecorded and lots of blank cassettes; and don't forget to buy a pair of tweezers—the wife might not lend you hers.

R-E

SOLID-STATE FUZZ BOX

Add a new dimension to your guitar amplifier

by JACK JAQUES

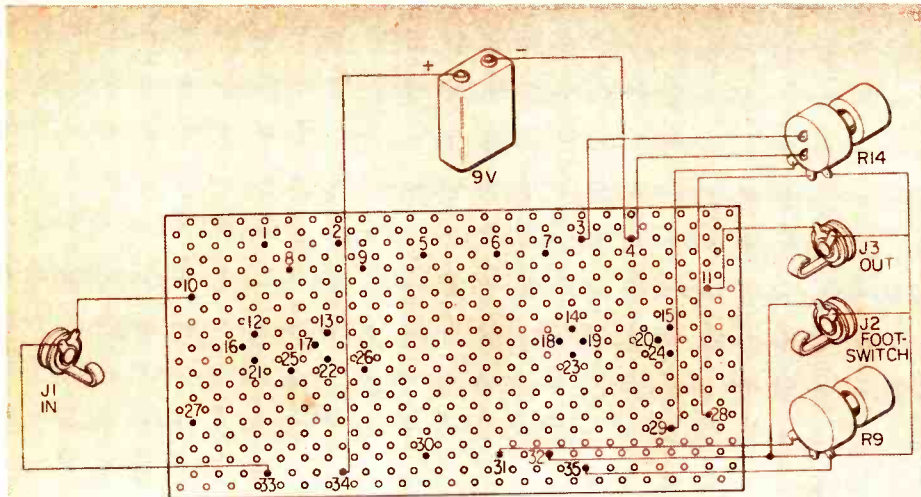

TOP VIEW
EXTERNAL CONNECTIONS

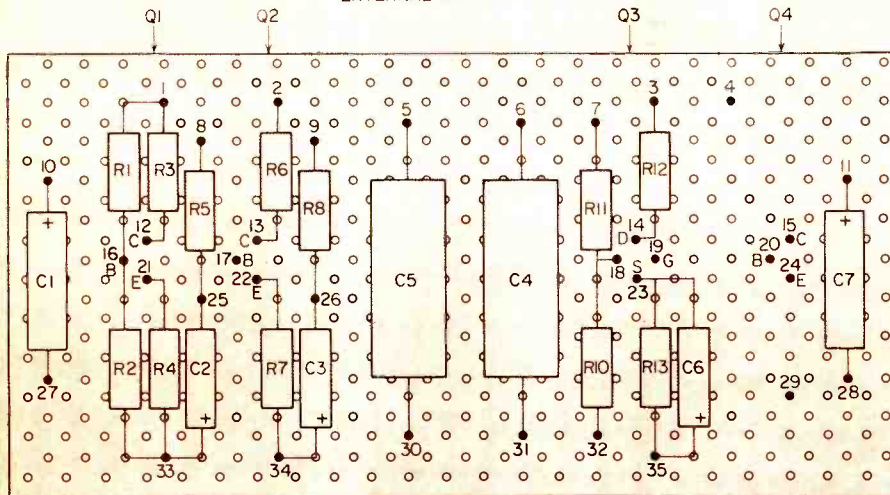

TOP VIEW
PARTS LAYOUT AND WIRING

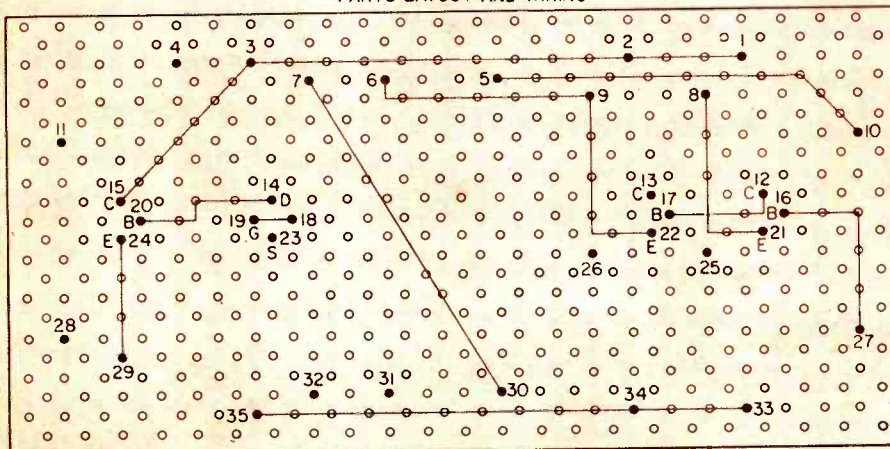

BOTTOM VIEW
WIRING

THE "FUZZ BOX" IS VERY USEFUL FOR converting the essentially "clean" output tone of an electric guitar into a distorted sound with a high harmonic content that gives the guitar a more "dynamic" sound. This "Fuzz Box," through the use of a footswitch, will either give the guitar a "clean" output or add a variable amount of distorted sound.

The circuit performs two functions: one a squaring amplifier and one a mixer. The squaring amplifier generates a square wave with rapid rise and fall times. This shape of wave contains many harmonics of the fundamental and the wave is clearly distorted. Q1 and Q2 comprise a high-gain easily saturated amplifier. For any signal above about 10 mV the output is a square wave. The output of the squaring amplifier is taken from the emitter of Q2 and as a result, there is a 180° phase shift between the input and output of the squaring amplifier.

The output of the squaring amplifier and input to the Fuzz Box are then applied to the audio mixer, Q3 and Q4. Transistor Q3 is a P-channel field-effect-transistor (FET) which, through its reverse biased gate has a very high input impedance. The mixing is done through R10 and R11 and Q3. Q4 is an emitter follower used to provide a low output impedance.

Potentiometer R9 varies the level of the square wave applied to the mixer. This varies the amount of distortion in the output from none to a square wave with slightly decreased peaks. The presence of the fuzz is controlled by the footswitch. The contacts are normally closed to ground out the square wave input and allow only the guitar input to go to the audio mixer. When the footswitch is depressed the square wave and guitar output are mixed. As the two signals

Top view shows numbered connections to various controls, inputs and battery.

Middle: top view of perf board showing positioning of most of the components.

Bottom view shows wiring between numbered terminals underneath the board.

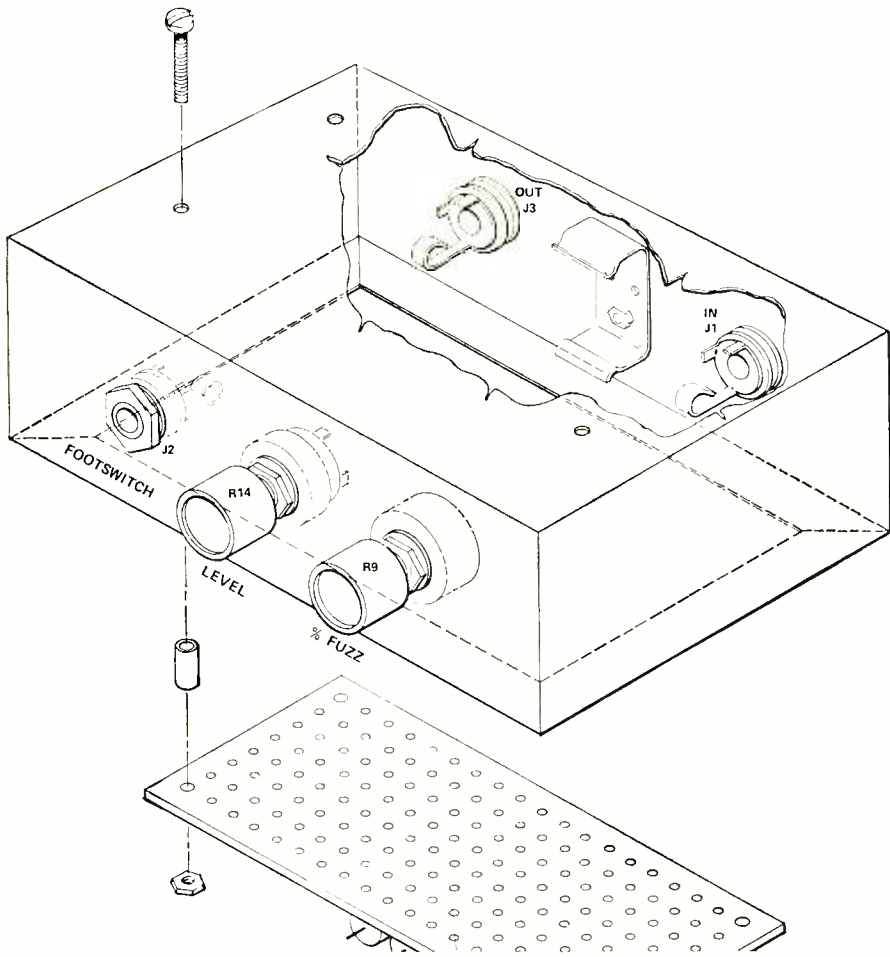

are mixed 180° out-of-phase, the fundamental is suppressed and the harmonics become more apparent.

Potentiometer R14 along with switch S2, to turn the unit on and off, varies the output level. Since the audio mixer has a small gain, R14 can be used to adjust the gain to make the output comparable to the guitar's output.

To use the Fuzz Box connect the guitar's output to J1. The output level of the guitar should be from 10 to 100 mV with 45 mV being ideal. This will allow for the most effective control of the PERCENT FUZZ. The footswitch is plugged into J2 and left alone for a "clean" output and depressed to get the "fuzz" output. The footswitch listed has spdt contacts and must be disassembled to connect the cable. The cable's shield should be connected to the contact arm and the case while the inner cable should be connected to the normally closed contact. The output, J3, is connected to the guitar amplifier, which is then operated in a normal fashion.

To keep from having a large change in volume occur when switching from no "fuzz" to maximum "fuzz," the guitar's output should be adjusted to a level that is comparable to the squaring amplifier's output. **R-E**

PARTS LIST

C1—6- μ F, 15V capacitor, electrolytic
 C2—30- μ F, 15V capacitor, electrolytic
 C3, C7—10- μ F, 15V capacitor, electrolytic
 C4, C5—0.5 μ F, 100V capacitor
 C6—100 μ F, 15V capacitor, electrolytic
 All resistors $\frac{1}{2}$ W, 10%

R1—150,000 ohms
 R2—27,000 ohms
 R3—220,000 ohms
 R4—33,000 ohms

R5—330 ohms
 R6—47,000 ohms
 R7—18,000 ohms
 R8—1,000 ohms
 R9—25,000 ohms, linear potentiometer
 R10, R11—100,000 ohms
 R12—6,800 ohms
 R13—10,000 ohms
 R14—2,500 ohms, linear potentiometer
 Q1, Q2, Q4—HEP57 pnp transistor (Motorola)

Q3—HEP803 p-channel field-effect transistor (Motorola)
 J1, J2, J3—Phone jack
 PL1—Phone plug
 B1—9-volt battery
 S1—spdt switch
 S2—spst switch
 MISC—Battery holder, 6 x 4 x 2-inch chassis (Bud AC-431), mounting board (Keystone 1905), connecting terminals, cable, transistor sockets.

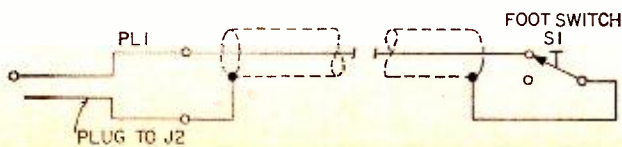
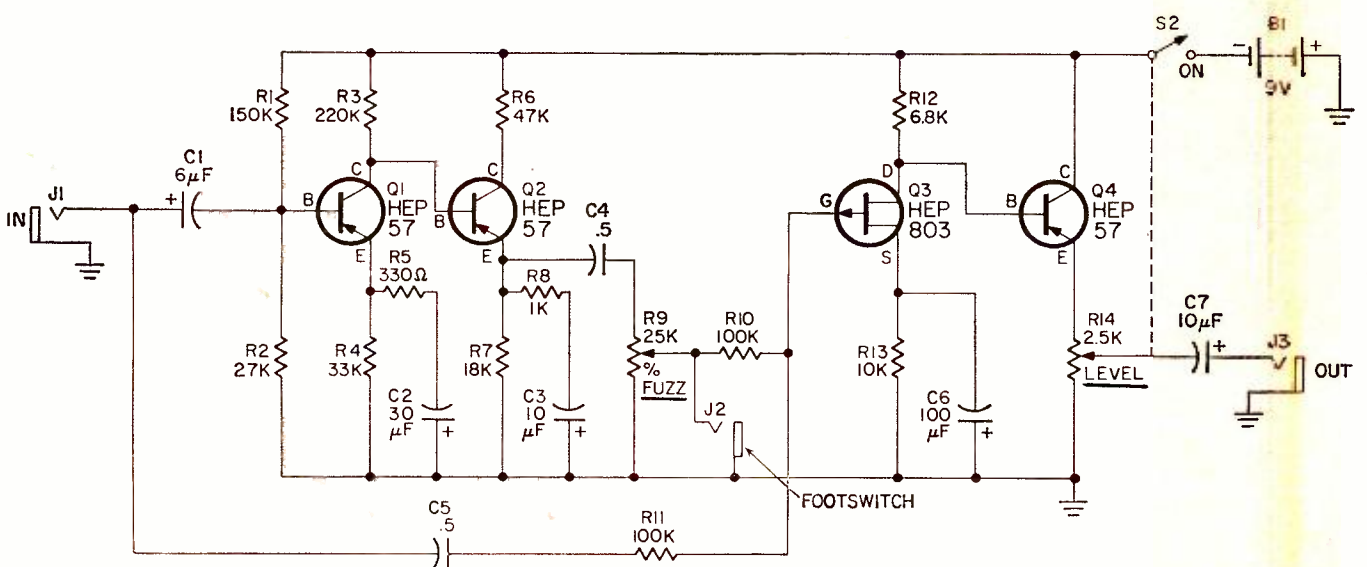

Dynamic "fuzz" sound occurs when output of squaring amplifier Q1-Q2 is mixed with input to the Fuzz Box in Q3.

of the voltage indicates how much the antenna must turn to restore balance.

The RCA circuit

In this unit (Fig. 2), elements R1-R4 correspond to those in Fig. 1-a, with trimmers R2 and R3 being represented by R2-a/R2-b and R3-a/R3-b. The transistors make up the detector and amplifier.

To orient the antenna, the control knob is turned to the desired direction. The knob—on R4—is ganged to

main in the counterclockwise (rest or normally closed) position because there is no current through its coil. With RY1's contacts holding the power on, the motor rotates counterclockwise, turning the antenna and R1.

When the desired aiming point is reached, the error voltage is around -0.25. At this bias level, Q1 and Q2 start conducting so Q2's collector current energizes RY2, causing its contacts to move to the clockwise position. During the interval that the relay

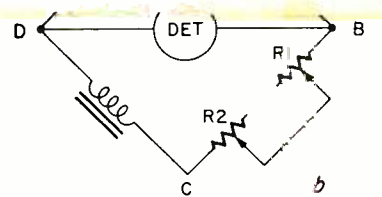
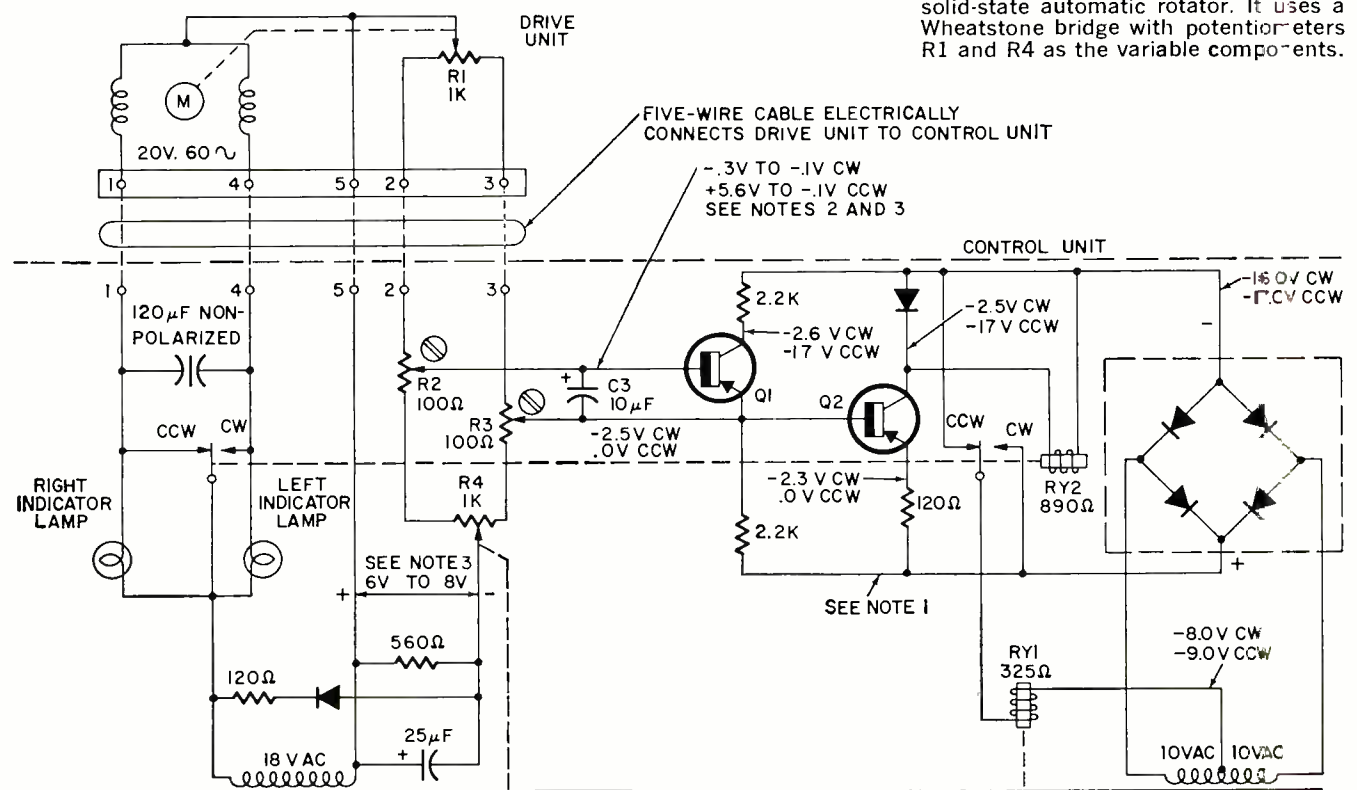

Fig. 1—Basic bridge circuits used to control the rotators. One (a) is a resistive Wheatstone bridge. The other (b) is a R-L phase-sensitive type.

Fig. 2—Schematic of the RCA 1CW707 solid-state automatic rotator. It uses a Wheatstone bridge with potentiometers R1 and R4 as the variable components.



NOTES:
 1. REFERENCE FOR ALL VOLTAGE MEASUREMENTS, EXCEPT AS NOTED.
 2. VOLTAGE MEASURED ACROSS C3 WITH EMITTER REFERENCE.
 3. LIGHT OF REDNESS CALIBRATED

by **ROBERT F. SCOTT**
SENIOR TECHNICAL EDITOR

AS HIS INTEREST IN COLOR OR UHF TV reception is aroused, many a homeowner finds his original black-and-white antenna system is obsolete. It covers only channels 2 through 13 and lacks the gain and bandwidth for good color reception. Too, it is sited for receiving reception from only one direction, while he is now within range of stations at several points around the compass. So, his new vhf/uhf installation must include a rotator that will aim the antenna at the desired station.

If he wants simple operation, pinpoint accuracy and positive sync between the rotator and control unit, he will probably select one of the new solid-state automatic rotators such as the Alliance C-255 Tenna-Rotor, Cornell-Dubilier AR-33 or RCA's model 10W707. You are going to install and service many of these units, so you'll want to know how they work and how to service them.

Like the more common nonelectronic rotators, the control circuits are based on a bridge with two potentiometers as variable elements. One potentiometer is turned by the dial on the control box and the other is driven by the rotator motor so the position of the arm is directly related to the antenna position. When the bridge is unbalanced by turning the pot on the control box, solid-state circuits amplify the error voltage and determine the direction the antenna (and potentiometer in the rotator) must be turned to restore the bridge to balance. The antenna points in the direction indicated on the control box when the bridge is balanced.

Two types of bridges (Fig. 1) are used in the rotators described in this article. In the basic resistive Wheatstone bridge in Fig. 1-a, the voltage is



Pushbutton feature on Cornell-Dubilier AR-33 permits fixed settings.

How they work— New solid-state TV rotators

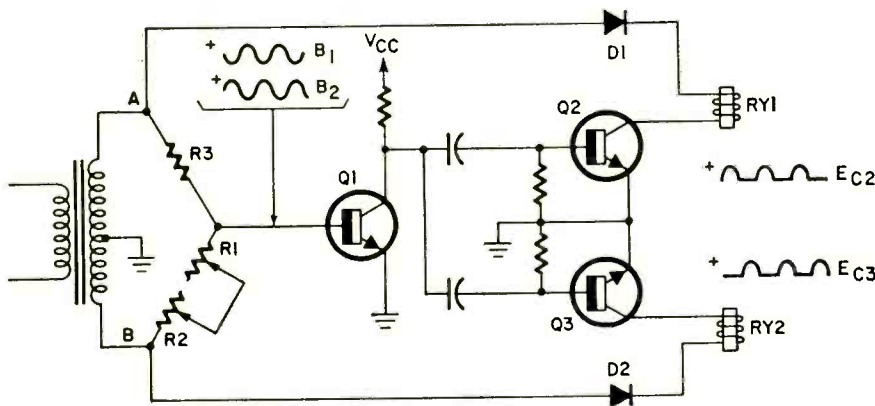

Fig. 3—Basic circuit of the AR-33 by Cornell-Dubilier. Phase relationship of

contacts are moving from the counterclockwise to clockwise position, the circuit to RY1's coil is opened. The contacts of RY1 quickly open, turning off the power to the motor and detector/amplifier circuits.

Now, if the bridge had been unbalanced clockwise, the voltage on Q1's base would have ranged from -0.3 to -0.1 volt. This would have turned on the transistors and energize

waveforms and direction motor turns depend on setting of pot R1.

RY2 so the motor would turn clockwise. The motor runs until the voltage across the bridge again approaches -0.25 . The transistors cut off, de-energizing RY2 so power is turned off during the switching interval.

(Note that the operating threshold voltage is around -0.25 volt in either case. The transistors turn off at this level if the bridge has been unbalanced in the clockwise direction and

turn on if the initial bridge unbalance was counterclockwise.)

Phase-sensitive controls

Cornell-Dubilier's AR-33 Autorotor uses a phase-sensitive bridge as the heart of a control system operated by either five preset pushbuttons or a 360° dial. Positioning accuracy is 1° . The basic circuit of the AR-33 is shown in Fig. 3 and the complete schematic is in Fig. 4. The functions and positions of R1, R2 and R3 correspond to those in Fig. 1-b.

When the bridge is unbalanced, an ac voltage is fed to the base of Q1. The phase of this ac error voltage with respect to ground is determined by the direction of unbalance. Wave-form B₁ and B₂ show relative phase relationships for cw and ccw unbalance. Diodes D1 and D2 supply out-of-phase, half-wave positive pulses to the collectors of Q2 and Q3. Points A and B—the opposite ends of the center-tapped secondary—are 180° out of phase. When A is positive, D1 conducts and a positive pulse appears at Q2's collector. At the same time, point

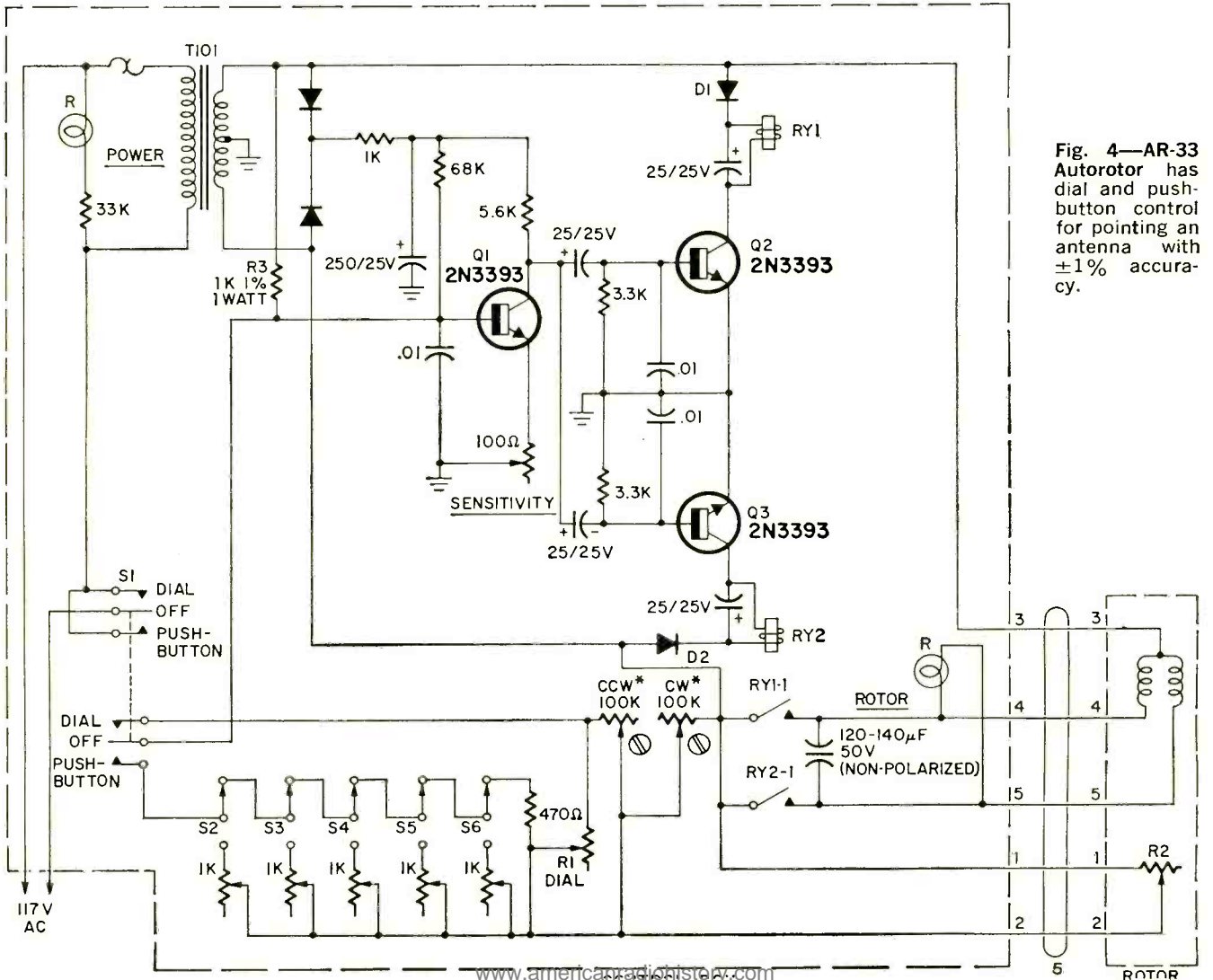
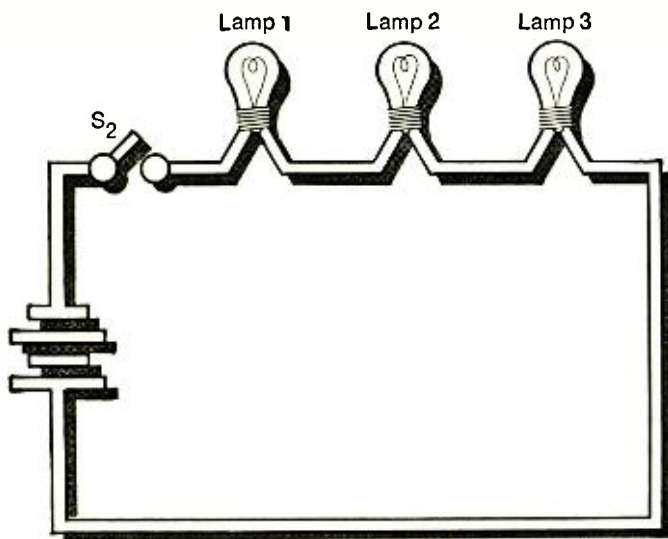

Fig. 4—AR-33 Autorotor has dial and push-button control for pointing an antenna with $\pm 1\%$ accuracy.

Can you solve these two basic problems in electronics?



This one is relatively simple:

When Switch S_2 is closed, which lamp bulbs light up?

Note: If you had completed only the first lesson of any of the RCA Institutes Home Study programs, you could have solved this problem.

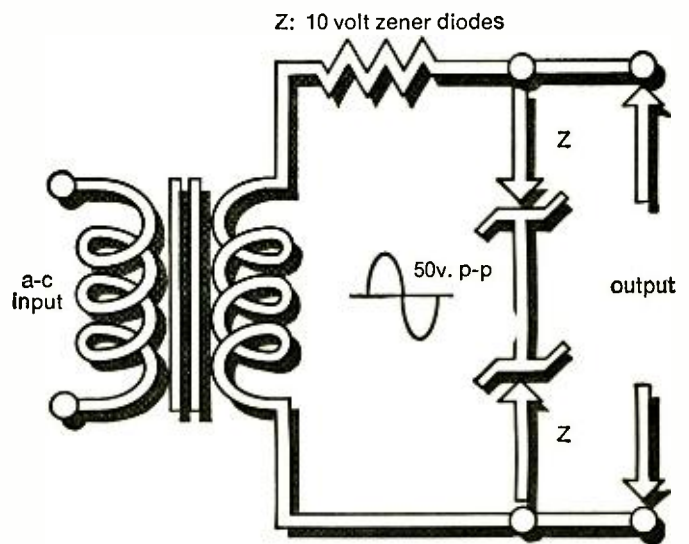

This one's a little more difficult:

What is the output voltage (p-p)?

Note: If you had completed the first lesson in the new courses in Solid State Electronics, you could have easily solved this problem.

These new courses include the latest findings and techniques in this field. *Information you must have if you are to service today's expanding multitude of solid state instruments and devices used in Television, Digital, and Communications Equipment.*

If you had completed an entire RCA Institutes Home Study Course in Semiconductor Electronics, Digital Electronics, or Solid State Electronics, you should now be qualified for a good paying position in the field you choose. Send for complete information. Take that first essential step now by mailing the attached card.

ANSWERS: Problem 1—they all light up
Problem 2—20 Volts (p-p)

RCA Institutes Autotext learning method makes problem-solving easier... gets you started faster towards a good-paying career in electronics

Are you just a beginner with an interest in electronics? Or, are you already making a living in electronics, and want to brush-up or expand your knowledge? In either case, RCA has the training you need. And Autotext, RCA Institutes' own method of Home Training will help you learn more quickly and with less effort.

Wide Range of Courses

Select from a wide range of courses. Pick the one that suits you best and check it off on the attached card. Courses are available for beginners and advanced technicians.

Electronics Fundamentals
 Black & White Television Servicing
 (Transistorized TV Kit Available)
 Color Television Servicing (Color TV Kit Available)
 FCC License Preparation
 Automatic Controls
 Automation Electronics
 Industrial Electronics
 Nuclear Instrumentation
 Electronics Drafting
 Computer Programming



Build and keep this valuable oscilloscope.

Plus these new up-to-the-minute courses

Semiconductor Electronics
 Digital Electronics
 Solid State Electronics
 Communications Electronics

Prepare for good paying positions in fields like these

Television Servicing
 Telecommunications
 Mobile Communications
 CATV
 Broadcasting
 Marine Communications
 Nuclear Instrumentation
 Industrial Electronics
 Automation
 Computer Programming
 Solid State
 Electronics Drafting



In the new program on Solid State Electronics you will study the effects of temperature and leakage characteristics of transistors.



Variety of Kits—Yours to Keep

A variety of RCA Institutes engineered kits are included in your program of study. Each kit is yours to keep when you've completed the course. Among the kits you construct and keep is a working signal generator, a multimeter, a fully transistorized breadboard superheterodyne AM receiver, and the all-important oscilloscope. These 4 kits are at no extra cost. Compare this selection with other home study schools.

Two Convenient Payment Plans

Pay for lessons as you order them. No contract obligating you to continue the course. Or, you can take advantage of RCA's convenient monthly payment plan. No interest charges!

Classroom Training Also Available

RCA Institutes operates one of the largest technical schools of its kind. Day and evening classes. No previous training is required. Preparatory courses are available. Classes start four times a year.

Job Placement Service, Too!

Companies like Bell Telephone Labs, GE, Honeywell, IBM, RCA, Westinghouse, Xerox, and major radio and TV networks have regularly employed graduates through RCA Institutes' own placement service.

All RCA Institutes courses and programs are approved for veterans under the new G.I. Bill.

Send Attached Postage Paid Card Today. Check Home Study or Classroom Training.

Accredited Member National Home Study Council.

IF REPLY CARD IS DETACHED, SEND THIS COUPON

RCA Institutes Inc.

Home Study Dept. RED-9
 320 West 31 Street
 New York, N. Y. 10001

Please send me FREE illustrated career catalog.

Name _____ Age _____
 (please print)

Address _____

City _____ State _____ Zip _____

Build An Automatic Enlarger Timer

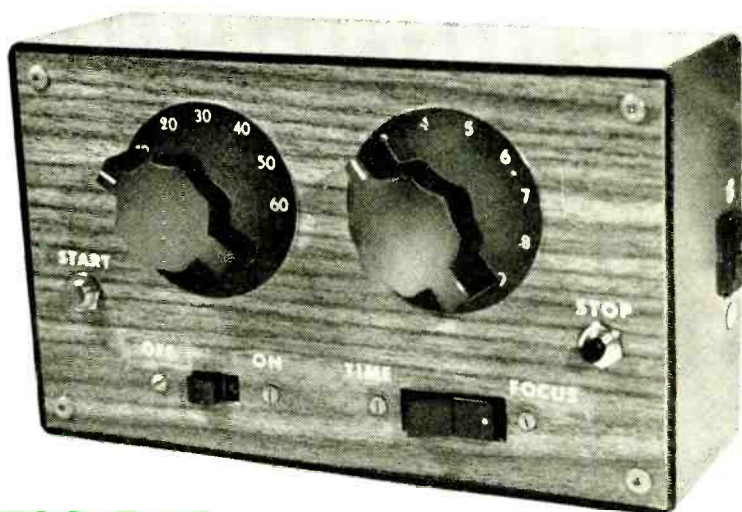

Solid-state reliability. Resets itself after 1 to 69-second interval

by **HERBERT ELKIN**

AN AUTOMATIC PHOTOGRAPHIC ENLARGER timer is an invaluable darkroom accessory. The timer leaves the photographer's hands and mind free to concentrate entirely on the photographic creation.

The schematic in Fig. 1 is a solid-state, automatically resetting timer.

PARTS LIST

- C1—47- μ F, 20V, 10% electrolytic tantalum capacitor (Mallory type CSR13-E476KL or equal; see note below under relay RY1)
 - C2—100- μ F, 150V electrolytic capacitor
 - C3—0.005- μ F, 600V ceramic capacitor
 - All resistors $\frac{1}{2}$ W, 10% or better unless noted
 - R1—2000 ohms, 5%
 - R2—20,000 ohms, 5%
 - R3—R10—22,000 ohms
 - R11—R16—220,000 ohms
 - R17—270 ohms
 - R18—47 ohms
 - R19—10,000-ohm, $\frac{1}{4}$ W linear potentiometer
 - R20—150 ohms
 - R21—100 ohms, 2W
 - R22—12,000 ohms, 2W
 - R23—15,000 ohms, 2W
 - R24—68,000 ohms
 - R25—10,000 ohms
 - D1, D2—750-mA, 400PIV, diode
 - D3—27-volt, 1W, 5% Zener diode (Motorola 1N4750A or equal)
 - Q1—2N2647 unijunction transistor (G.E.)
 - SCR1—C106F2 silicon controlled rectifier (G.E.)
- Other parts**
- RY1—4pdt, 125-mW, 2500-ohms, 8.4-mA dc relay (Allied Control TS154-4C. Available from Newark Electronics Corp., 500 N. Pulaski Rd., Chicago, Ill. 60624 for \$3.96 plus 2 oz. postage ppd. Stock No. 59F512, 1969 catalog). Capacitor C1 is \$2.82, Stock No. 17F1542.
 - S1—slide switch
 - S2, S3—1-pole, 12-position rotary switch (Mallory 32112J or equal)
 - S4—N.O., momentary pushbutton switch
 - S5—N.C., momentary pushbutton switch
 - S6—rocker switch
 - MISC—ac socket, $6\frac{3}{8}$ x $3\frac{3}{16}$ x $1\frac{1}{8}$ -inch bakelite case with aluminum panel (Lafayette 99T 6272), knobs, perf board, transistor socket

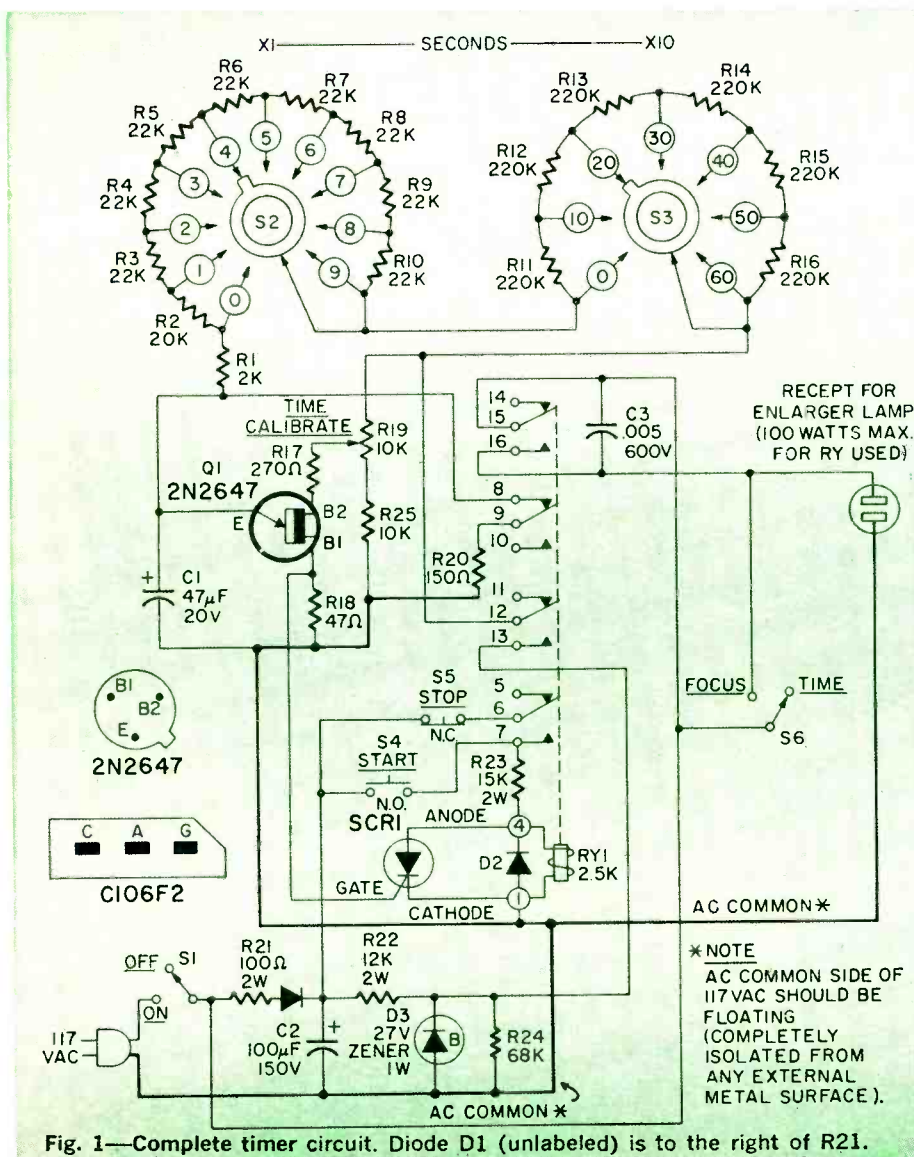

Fig. 1—Complete timer circuit. Diode D1 (unlabeled) is to the right of R21.

The advantages of a solid-state device over a mechanical timer are the elimination of noise, vibration, manual resetting, and increased reliability. The device is capable of timing intervals from 1 second to 69 seconds in 1-second intervals.

The time interval is set by two rotary switches. Switch S3 sets intervals of 10 seconds and switch S2 sets unit intervals additively. The timer is activated by momentarily pressing START switch S4. When the timing cycle terminates, the device is automatically reset and is ready to be activated again by pressing the momentary START switch. STOP switch S5 provides an abort capability before the end of the timing period if a timing interval has been erroneously set. The unit's recovery time is in the millisecond range, which is advantageous when making test strips.

Timing accuracy is better than 2% up to 30 seconds, after which accuracy falls off slightly due to the leakage current of tantalum capacitor C1. The unit provides exact time interval repeatability, which is important for consistent print results. Time interval resettability is of more importance than the slight loss of accuracy (2-5%) at intervals above 30 seconds. Most enlarging situations call for less than 30 second exposures.

How it works

Relay RY1 is energized during timing and applies 117 Vac to the enlarger via the ac receptacle. The power supply is a half-wave type consisting of R21, D1, C2, R22, D3 and R24, and supplies an unregulated dc voltage to operate relay RY1 and a +27 volts dc, regulated by Zener diode D3. The regulated voltage provides an accurate reference voltage to the timing section of the device.

The heart of the timer is unijunction transistor Q1, used as a single-cycle relaxation oscillator. The timing interval is varied by switching resistance values (R1-R16 additively) in the unijunction emitter circuit to vary the RC time constant.

At the end of the timing cycle (when C1 charges to the proper stand-off voltage at the unijunction emitter), a pulse is generated at Base 1 of the unijunction. The pulse is applied to the gate of silicon controlled rectifier (SCR1), which then conducts current around RY1 causing the relay to release and end the timing cycle.

Here is an outline of the timing cycle:

1. Momentarily depressing START switch S4 applies the unregulated voltage through R23 to RY1, which puts the four relay contacts

in the activated position.

2. When the START switch is released, the relay remains activated as the holding current is supplied through the normally closed STOP switch S5 and through the closed relay contacts 6 and 7. If it's desired to terminate a timing cycle before the interval set, the STOP switch can be momentarily pressed, interrupting the relay holding current and releasing the relay.
3. With RY1 activated, the enlarger lamp receives 117 volts ac through contacts 15 and 16. +27 volts is supplied to the unijunction circuit through contacts 12 and 13, and

- R20 is removed (contacts 8 and 9 are open) from across C1.
4. When Q1 fires at the end of the timing interval, the positive pulse generated at Base 1 triggers the SCR, which then bypasses current around the relay coil, causing the relay to release.
5. Since the SCR anode voltage is supplied through relay contacts 6 and 7, the SCR anode voltage is removed when the relay releases. Therefore, the SCR is restored to a nonconducting state and the timer is automatically ready for a new timing operation initiated by the START (S4) button.

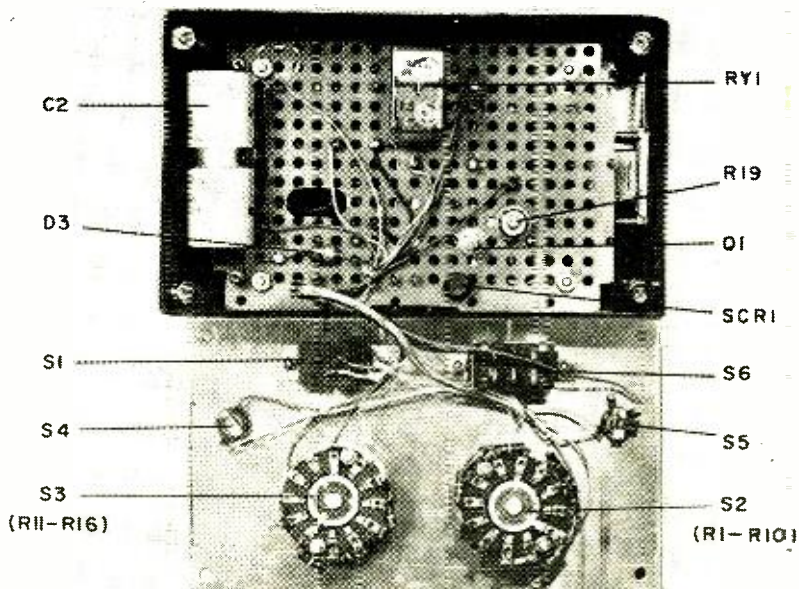

Top view of mounting perf board. Make sure S2 and S3 have adequate clearance.

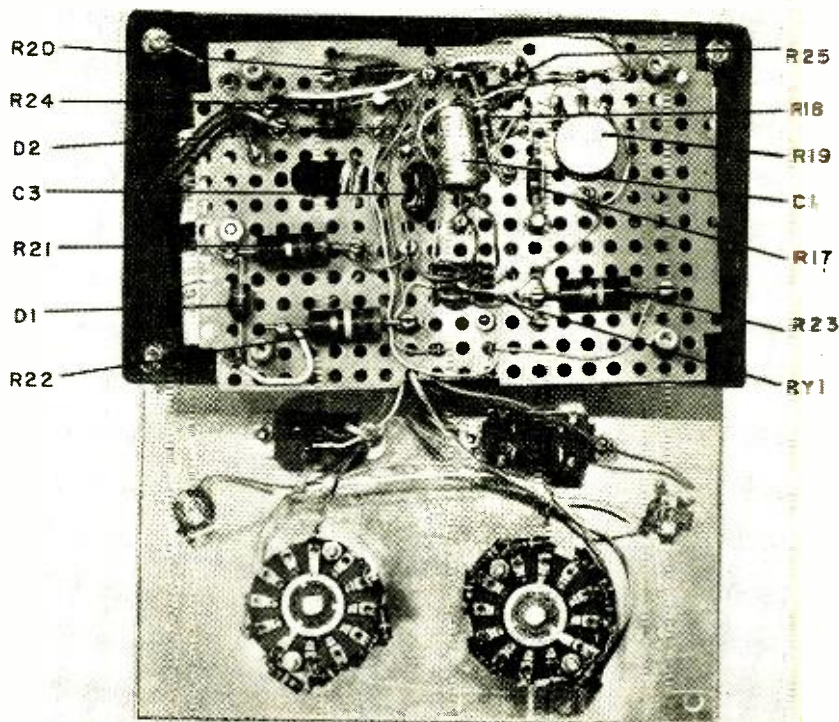

Bottom view of component board. An external relay extends wattage capability.

6. When the relay releases, contacts 15 and 16 open, the enlarger lamp is turned off, the regulated +27 volts is removed from the unijunction circuit, and R20 is placed across C1. R20 completely discharges capacitor C1 within milliseconds to assure that when a new timing cycle is started the initial voltage on C1 will always be zero. This insures an accurate timing interval.

Capacitor C3 is across relay contacts 15 and 16 for arc suppression. Diode D2 is across the coil of RY1 to eliminate transient spikes during relay turnoff, which could damage the SCR and/or the relay coil. The 1-second timing resistance is divided into two resistors, R1 and R2. R1 is always in the timing circuit and provides protection for Q1 if the timer is started with switches S2 and S3 accidentally left in the 0 second position. R1 contributes only a small error (less than 1%) when S2 is set to 0 and the S3 (x10) resistances are in use.

Provision is made for accurate calibration using potentiometer R19. By means of R19, the interbase voltage can be varied, thus controlling the firing point of the unijunction transistor (the firing point voltage at Q1's emitter is equal to the stand-off ratio (η) x the voltage across Q1, Base 1 to Base 2). The $\pm 10\%$ tolerance of C1 and the variation in the stand-off ratio of Q1 (0.68–0.82) are balanced out using R19. Although the timing resistors are $\pm 5\%$ tolerance, it can be shown that the timing accuracy is better than 2% (if the leakage current in C1 is considered negligible).

Construction

The cabinet is a $6\frac{3}{8}$ x $3\frac{3}{16}$ x $1\frac{7}{8}$ -inch bakelite utility case. A 117-volt isolation transformer was not used

to make the unit compact. If the bakelite case is used and all circuitry is isolated from the metal front panel, the transformer is not required in the circuit.

The components were mounted on a phenolic perforated board which was fastened to the bottom of the bakelite case using spacers (legs) to allow clearance for the components mounted on the bottom side of the board. Rotary switches S2 and S3 were mounted on the front panel so that the space left between them was sufficient for the relay clearance. FOCUS-TIME switch S6 is a "see-saw" (or "rocker") type which adds to the convenience and simplicity of operation. The relay was selected because of its low operating power (175 mw). The contact rating of the relay will allow it to switch an enlarger lamp of up to 100 watts (within the range of most home enlargers).

If you wish to use the timer with a higher-wattage lamp, use the unit to switch another external high-contact-current relay. Capacitor C1 is a tantalum capacitor and no other type should be used since a low-current-leakage capacitor is required. The ac common points on the schematic in Fig. 1 should be joined together and connected to the indicated side of the power line; do *not* ground this side of the power line to the front panel.

Calibration and use

As with all electronic gear, the power supply should be checked out first before connecting the circuitry. Leave the connection to relay pin 13 open until the voltage is checked. Double check the power supply wiring and then turn power on. The voltage on the open lead should be +27 volts dc.

Set potentiometer R19 to mid-

range and the FOCUS-TIME switch S6 to TIME. Set the timer for 5 seconds (S2 to 5 and S3 to 0). Start the timer by momentarily pressing the START switch S4. Adjust potentiometer R19 for a 5-second cycle. You will hear the relay drop out at the end of the cycle. Check the timing interval at 10, 15, 20, and 30 seconds and touch up the adjustment of R19 if necessary. All time intervals up to 30 seconds should be accurate to 2%. Check the timing at 40, 50, and 60 seconds. The accuracy should be from 2 to 5%. A 5% error at these settings will not at all be noticeable in the finished print.

If the error above 30 seconds is large (which will be rare) it is because C1 has exceptionally high current leakage. If C1 is not completely defective, the accuracy above 30 seconds can still be improved. Since C1 is a relatively high-cost item, the following procedure should be followed rather than to discard the capacitor. Set S3 to the shortest time at which the accuracy is to be improved (say 50 seconds) and S2 to 5 seconds. Replace R15 with a 500K pot and adjust for an accurate 55-second interval.

The potentiometer can be left in as part of the circuit or the potentiometer resistance can be measured and a fixed resistor substituted. Repeat the procedure for the next highest time setting of S3 (60 seconds and R16 in this example) after the selected resistor is soldered into the circuit. Leave S2 set to 5 seconds.

With switch S1 on and the FOCUS-TIME switch S6 set to FOCUS, the enlarger will be continuously on. After selecting negatives and focusing the enlarger, set S6 to TIME. The lamp will be switched off and the timing interval set by S2 and S3 can then be initiated by pressing START switch S4.

R-E

TOOLS FOR ELECTRONICS

by TOM HASKETT

This issue, starting on the facing page, is the fourth part of our new series of articles on tools for electronics. It winds up our description of screwdrivers. Next month we will continue the series with the first part of an article on wrenches and how to use them. We believe you will find all of this material a handy, practical addition to your R-E Reference Manual.

If you wish you can purchase a special hardcover binder to keep your Reference Manual pages together. It has a dark blue fabric cover and is gold stamped Radio-Electronics Reference Manual. The cost is \$1.00, postpaid. Order from N. Estrada, 17 Slate Lane, Central Islip, L.I.

Another way of obtaining greater torque with a given screwdriver is to use GC Electronics' **Twistmaster** handle No. 9320 (Fig. 22). It's a

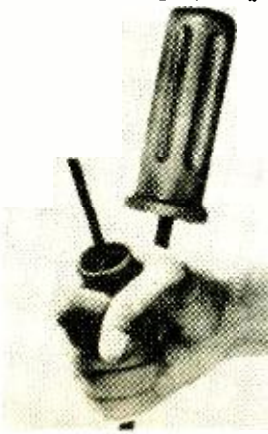

Fig. 22—Need more torque? Try the G-C Electronics Twistmaster handle No. 9320. Slip it over existing tool handles to increase diameter, improve grip and boost torque.

hollow handle which you slip on the handle of your present driver, giving you greater driving power.

A somewhat similar device, called the **Torque Amplifier**, is made by Xcelite (Fig. 23). It is used with screw- and nut-driver sets. The



Fig. 23—This torque amplifier is made by Xcelite. It is a part of many of their "tool kits". These are sets of small screwdrivers, nutdrivers and other similar tools. They go a long way to help speed removal of "tight" hardware.

hollow handle slips over the handles of miniature drivers, to give you more turning power. Several kits available from Xcelite using the **Torque Amplifier** include slot, Phillips, Scrulox and Allen blades.

Amalite's **swivel-top handle driver** (Fig. 24) is made in two parts, with the end of the handle turning freely. Thus you can apply steady



Fig. 24—Swivel-top screwdriver is made in two parts, with the end of the handle turning freely. Lets you apply steady pressure while turning this Amalite driver.

pressure to the handle end while turning the body of the handle, thereby speeding up the job.

Specialized screwdrivers

If you have to install or remove a lot of screws, your forearms get tired and you may work up a blister. One comfortable solution is a ratchet screwdriver (Fig. 25). It has a button on the blade near the handle, and can be set for ratchet left, ratchet right, or no ratchet

for the driver and one hand? How do you hold the screw in place to start it? One way is to use a **screw launcher** (Fig. 27) which holds the screw and lets you start it in the threads. Then you remove the launcher from the screwhead and use a regular driver.

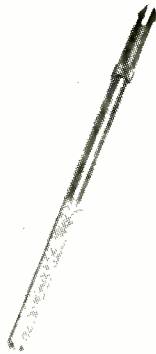

Fig. 27—Screw Launcher starts screws in tight corners. Then tool is retracted and standard driver is used to complete procedure. Unit shown is the Vaco model K-19.

Another way of overcoming the problem is to use a **screw-holding driver** (Fig. 28). It's similar to a conventional screwdriver, but the blade is split and a movable ring allows you to wedge the split tip apart inside the screw slot, holding the screw so you can drive it in (or remove it).

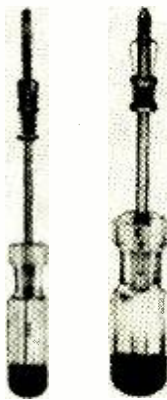

Fig. 28—These screw-holding drivers do about the same job. The top one (Crescent model 247) is for standard screws. The bottom one (Crescent model 261) is for Phillips head screws. Other types of screw-holding drivers are also made.

Some screw launchers and screw-holding drivers are available for Phillips and Reed & Prince screws.

Stevens Walden **In-a-Grip** wrenches are a bit unusual; they're screw-holding Allen drivers (Fig. 29). The blade is a split-spring hex,



Fig. 29—Here's a screw-holding Allen driver. The blade is a split-spring hex you insert in the screwhead. The driver shown is a Stevens Walden model 36HP4.

which you force together and insert in the screwhead. Thus you can drive the screw with one hand, and simply pull the driver out when you're finished.

Some screwdrivers have removable, **reversible blades** (Fig. 30) which double the usefulness of a single driver. The reversible blade usually has a slot tip on one end and a Phillips on the other, although Vaco has a clutch-head blade available.

(straight screwdriver action). You simply turn the driver and drive the screw in, ratcheting back to get another bite (or vice versa). You don't

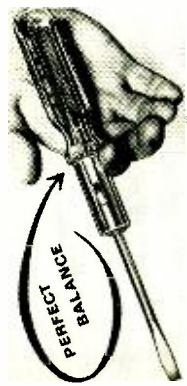

Fig. 25—Ratchet screwdriver can speed up inserting or removing screws considerably. Unit shown is the Vaco model 11101.

have to change your grip on the handle.

A ratchet mechanism is also used in the right-angle/offset screwdriver shown in Fig. 26. This type of driver is quite useful if you must



Fig. 26-a—Some offset drivers also use a ratchet action. On the left is the Chapman kit. It uses a ratchet drive and a set of interchangeable bits. The bits can be screwdriver or Allen head styles. The unit shown includes both kinds.



Fig. 26-b—Another type of ratchet driver has captive tips. These three different models offer a variety of tip combinations. All are manufactured by General Hardware.

work in close quarters where it is often difficult to remove and reseal the driver blade. Also, you may not have space to work the handle very far, but with ratchet action you need only a small space to turn the screw a little at each throw. Right-angle ratchet drivers are often socket types; a single handle comes in a kit with various insertable heads available—slot, Phillips and Allen (hex).

Have you ever tried to start a screw where there was room only

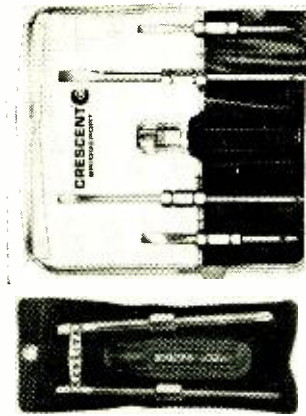

Fig. 30—These two screwdriver kits have reversible interchangeable blades, so each blade is actually two drivers. On the left is the Xcelite CK20 kit; on the right is the Crescent model 2700-4 kit.

The **handle-and-blade kit** (Fig. 31) carries the preceding idea a bit further, combining one or two handles with a number of interchangeable blades. It's useful for work away from your bench, since you can



Fig. 31-a—Handle and blade kits are another common convenient combination tool set. The Channellock model SD-5 combines standard and Phillips head drivers in one handy pocket-size package.

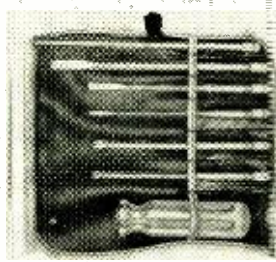

Fig. 31-b—Another type handle and blade kit is shown here. It rolls up into a neat package.

carry lots of tools in a compact space. Most kits contain one or two slot-tip blades, a Phillips and possibly an awl and a tack puller. Several manufacturers (Hunter, Peer, Vaco and Xcelite) have other blades: Reed & Prince, clutch, Scrulox, Allen and Bristol. Xcelite furnishes a taper-reamer blade with its kit. The best kits have snap-in blade seating; less expensive types have a screw-down finger chuck which takes more time to work.

Jeweler's screwdrivers are simply miniature drivers for tiny screws (Fig. 32). They usually have knurled handles and a swivel-end

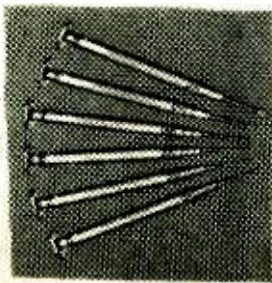

Fig. 32—Miniature jeweler's screwdrivers are often handy when you've got really tiny screws to handle. The set shown here is the Peer 41-068. A word of warning. Many of these tools are not insulated at all. The bit and shaft are all metal—please be careful.

finger-rest plate, and some have removable blades. They are generally available only with slot tips. You can buy these drivers individually, but most persons buy a kit of five or six, with tip widths from .025 inch to 0.100 inch.

Some color-TV receivers have dual, concentric setup controls, and it is often desirable to adjust both controls simultaneously. GC Electronics' No. 9299 **dual concentric** screwdriver (Fig. 33) has been designed for just that job.

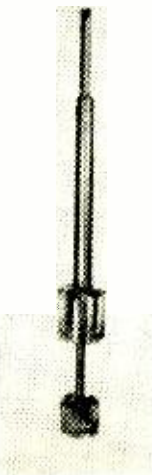

Fig. 33—This special dual-concentric screwdriver is specially made by General Cement (model 9299) for setting dual concentric controls simultaneously.

Shelton's **Versatool** (Fig. 34) is a multipurpose ratchet driver with both slot and Phillips blades which swivel to work straight-on or offset.

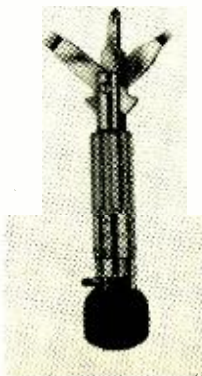

Fig. 34—Shelton Versatool offers three different screwdriver blades plus a ratchet in a single package. A nice novelty.

The same company's **4-Way Orbit Driver** (Fig. 35) is an unusual driver with four blades—two slot and two Phillips. It's palm-sized and useful for field work.

than a few months, spend a buck or two and get a professional-quality tool. A cheap screwdriver is no bargain.

Screwdriver use and care

Use the longest driver available which will fit the screw and the work space. You get more torque with a longer blade. Be sure the tip is thick enough to fit the screw slot; if it isn't, the driver will slip and deform both the tip and the screwhead. If you're driving anything but a slotted-head screw, you'll have to get a mating tool of the correct tip size. Don't use a slot tip that's wider than the screwhead, or you'll mar the surface of the work when you run the screw home.

If you're driving screws in wood and the hole's small and tight, rub a little soap into the screw threads. A clean machine screw should



Standard Stanley screwdriver has large plastic handle and conventional screwdriver tip. You need a variety of these tips to handle the many different screw sizes effectively and prevent damage to screw slots.

run into a threaded metal hole easily, but if either the screw or the hole is dirty or rusty, use a drop of oil to smooth the way; then you won't take a chance in breaking the screw off in the hole.

If you can't seem to get a screw out, squirt a little oil under the head and work the screw back and forth with the driver. You can usually loosen it this way.

A self-tapping screw threads its way through a panel, and you need a lot of torque to start it. Use a large driver and start with screw slowly and carefully. After the screw cuts threads in the panel the going gets easier.



A stubby screwdriver is an important part of any tool kit. You should have both standard and Phillips types in at least two different sizes. In tight quarters you'll find them hard to beat.

Always remember to use the right sized screwdriver for the job, and keep the blade clean. Never carry a driver in your pocket unless it has a clip; a loose driver can injure you severely if you trip and fall.



Fig. 35—4 Way Orbit Driver is palm sized and handy for field work. The one shown here has a G-E trademark, but the tool is actually made by Shelton.

You can buy **magnetized** screwdrivers, which are useful for starting or retrieving steel or iron screws. You can also magnetize a steel driver by rubbing its tip across a speaker magnet.

Sometimes magnetized screwdrivers can be a nuisance—especially around a tape recorder or a color TV receiver—where they may cause trouble. If you have a magnetized driver, you might want to keep it away from your other tools. If you want to demagnetize a screwdriver, use your solder gun or a degaussing coil. Energize the gun or coil and pass the driver blade through the coil (or into and back out of the gun-tip loop.)



Little screwdrivers with pocket clips are a great convenience but look for clips that are permanently attached. Slide on clips can also slide off when you least expect it.

How to buy screwdrivers

You will probably want to keep on hand an assortment of the drivers you need for the various screwheads you encounter in your work or hobby. You'll want small and large sizes, slotted, Phillips and perhaps others.

Try to get your hands on a driver before you buy it. The handle should be comfortable and not cut into your hand when you apply torque to a screwhead. The blade should be anchored with a pair of wings in the handle, and the best blades are made of tool steel or a good alloy with temper. Look at the tip closely; it should be clean and even, with no burrs or rough edges. You will find various prices, from perhaps 39¢ to several dollars. If you plan to use a driver for more

Don't use a screwdriver as a pry bar or a chisel, and don't hit the handle with a hammer. Never use pliers to turn a driver blade when removing a frozen screw. Get a square-bladed driver and use the correct size of right-angle wrench.

If a screwhead slot or recess is dirty, clean it out before applying a driver to it. Otherwise you may damage both the driver tip and the screwhead.



Grind the sides of the blade flat and you've got a more expensive driver. But it's a more convenient tool to use too; especially if the screw you want to get at is recessed or countersunk.

When a screwdriver becomes nicked or its edges rounded, or when other damage occurs and the tip doesn't fit the screw slot, you should file the tip or grind it back into shape. Put the driver in a vise and file it carefully until its shape is restored. If you grind a driver tip, dip it into water from time to time to prevent it from losing its temper.



Long bladed drivers are another must in any complete set of screwdrivers. Again a variety of tips are a must. You may not need this kind of driver often, but when you do . . .

Some drivers are plated with nickel or chrome, to keep them from rusting. Others aren't, and since they're made of tool steel they'll rust if you don't work them over with an oily rag now and then. If a driver does rust or gets dirty or grimy, clean it with sandpaper, emery cloth, steel wool or a wire brush until it's bright. Then rub it with a slightly oily cloth.





If you work with tape heads, color TV or similar magnetically sensitive equipment, you may want to demagnetize your screwdrivers from time to time. They have a bad habit of accidentally getting magnetized.

NEW R-E EXCLUSIVE

**GHS8 noise-canceling
sync/agg stage
sync separator section**

Kwik-Fix™ picture and waveform charts

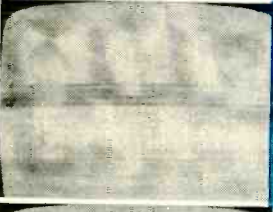
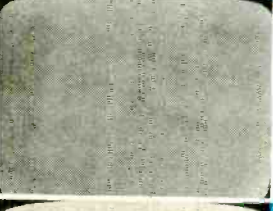
by Forest H. Belt & Associates*

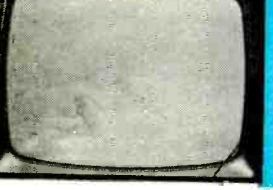
SCREEN SYMPTOMS AS GUIDES		WHERE TO CHECK FIRST		
SYMPTOM PIC	DESCRIPTION	VOLTAGE	WAVEFORM	PART
	Agc overload, nc sync, sound buzz	cathode-pin-1 screen-pin-2	WF2	R8 C5
	Weak picture, sync okay	G1-pin-7	WF2	R6 R7
	Weak picture, sync poor	G1-pin-7	not much help	C2
	Whiteout, sound remains	G1-pin-7	WF2	R7
	Whiteout, no sound	screen-pin-2 cathode-pin-1	WF3	R10 C5
	No sync, signs of overload, sound may buzz	G3-pin-9	WF4	C7 R12
	Agc lets i-f overload, sync fairly normal, sound buzz	screen-pin-2 G3-pin-9	WF2 WF5	R10

an Easy-Read™ feature by FOREST H. BELT & Associates © 1968

Use this guide to help you find which key voltage or waveform to check first. Study the screen and the action of the agc and noise gate controls. Most helpful clues to the fault are found at the key test points indicated.

Make voltage or waveform checks as indicated for screen symptoms. Use the Voltage Guide and Waveform Guide to analyze results. For a quick check, test or substitute the parts listed as the most likely cause of the symptoms.

THE CIRCUITS

This sync separator stage is popular, especially in color sets. The tube has twin-pentode construction, with elements common to both sides—cancelling noise for both sync separation and agc. This issue of Kwik-Fix™, number 7, covers the sync separator section; the prior issue, number 6, described the other half of the tube—keyed automatic gain control.

Grids 1 and 2 and the cathode are common to both sections, terminated in pins 7, 2 and 1, respectively. The sync section has its own separate G3 and plate, pins 9 and 8 (pins 3 and 6 are plate and grid 3 for age section). Grid 1 is the noise-canceling grid for both sections. Grid 2 is the screen grid for both; constant positive voltage there affects general conduction for the entire tube.

SIGNAL BEHAVIOR

Video-and-sync signal from video amplifier is applied through compensating network C6-R11-C7 to pin 9, which is separator grid. Sync pulses here are positive-going. They exercise strong control over conduction in this section of tube, when tube can conduct.

At same time, video signal with negative-going sync is applied to noise-canceling grid at pin 7 through C2. Bias is enough on grid-pin-7 that any signal of higher amplitude than sync pulses (such as noise) drives tube far into cutoff. No noise pulse can therefore be amplified, even if it reaches grid-pin-9, because same noise impulse (but opposite polarity) is cutting tube off at grid-pin-7.

Long time-constant of R12, load for grid-pin-9, lets signal level determine bias for G3. Grid-leak action sets bias voltage just above pedestal level of incoming sync-and-video signal. Video can't make tube conduct, nor can blanking pedestal. Sync pulses can, though. Output is sync signal minus video and blanking.

Any noise that appears above or between sync pulses is canceled by opposite version at grid-pin-7. Noise therefore doesn't appear in output, and can't foul up sync.

Capacitor C4 decouples screen grid, using cathode-bypass capacitor C5 as easy signal path to ground.

Horizontal sync and vertical sync both show up in output of sync separator. Small-value capacitor (not

shown) couples horizontal sync to horizontal afc stage; resistor and integrator network (not shown) couple vertical sync to vertical oscillator.

DC DISTRIBUTION

Plate voltage for this section of 6HS8 comes from 250-volt line through R13. Screen voltage comes through R10.

Bias between cathode and grid 1 of tube is set by controls R7 and R8. Noise-gate control sets level of operation for G1. Control is set for dc voltage level just below tips of incoming sync pulses, so pulses won't quite overcome dc voltage. Age control R8 adjusts cathode voltage—thus sets grid-cathode bias. R8 determines conduction for the amplitude of signal applied to separator grid (pin 9): it has little or no direct effect on sync, except in way age affects signals in rf and i-f stages.

Operating value of dc bias at grid 3 (pin 9) depends on level of blanking pedestals. A stronger signal develops more grid-leak bias across high-value R12, reducing amplification of sync pulses as well as keeping bias above pedestal level. A weaker video signal develops less grid-leak bias; amplification is higher, and bias drops down almost to pedestal level. Output is fairly constant-amplitude sync pulse.

QUICK TROUBLESHOOTING

When this section is faulty, it may also upset age section. ALWAYS start troubleshooting by clamping i.f. age stage at whatever value lets video get through normally to video detector and video ampl. Don't apply too much clamp voltage. Just clip variable dc supply to i.f. age line and turn up voltage control until picture is visible. If it's out of sync, that's okay. Leave age and noise gate set at center of rotation.

With video on screen, even though out of sync, use scope to check waveforms (see Waveforms as Guides). Many troubles in this section leave no dc clues; waveform analysis is usually quickest. If waveforms seem fairly normal, then check voltages with dc voltmeter.

Also see last Kwik-Fix™, number 6, which is companion to this one showing age side of the stage. **R-E**

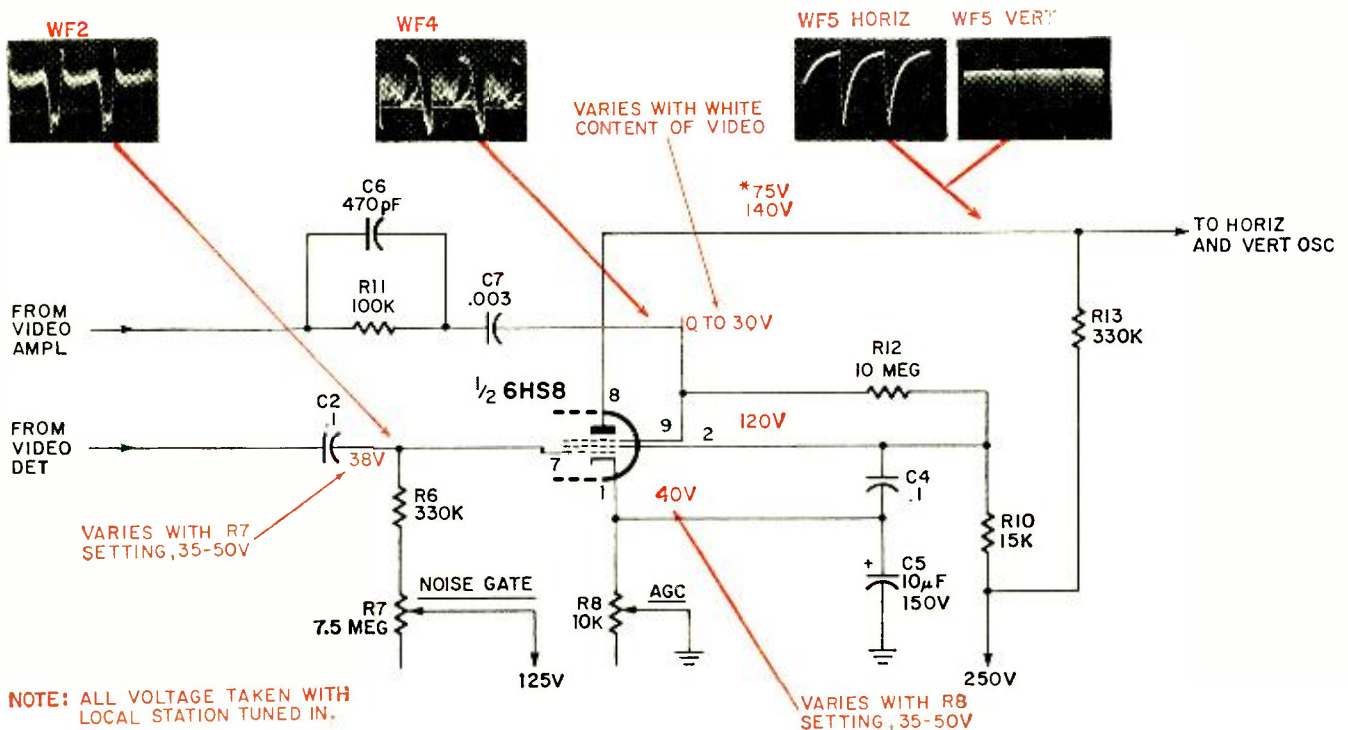

DC VOLTAGE AS GUIDES

Voltage change	to zero	very low	low	slightly low	slightly high	high
Cathode-pin-1 Normal 40 V. Varies from 35 to 50 volts with setting of R8. Develops as result of average plate conduction in tube.	R10 open C5 shorted	R7 open	R10 high C2 leaky C5 leaky	C7 open	C2 open C4 leaky	R8 open R10 open C2 open
Screen-pin-2 Normal 120 V. Is applied through R10 from 250-volt line.	R10 open C4 shorted	C4 shorted C5 shorted	R10 high C4 leaky C5 leaky	C4 leaky	R6 open C2 open C7 open	R7 open R8 open R10 low C2 leaky
G1-pin-7 Normal 38 V. Varies from 35 to 50 volts with setting of R7. Comes through R7 from 125-volt line.	R6 open R7 open R10 open	R6 high	R10 high C2 leaky C5 leaky	C2 open	C4 leaky	R8 open R10 low
Plate-pin-8 Normal 140 V. Varies with station signal rf level. Comes from 250-volt line through R13. In some chassis, also fed from lesser B-plus source—not shown here.	R13 open ¹	C2 leaky C7 shorted	R13 open C7 open C7 leaky	R12 shorted C5 leaky C7 leaky	R8 open	R13 shorted
G3-pin-9 Normal 10–20 V. Voltage depends on white content of video signal applied by C6-R11-C7. Developed by gridleak action across R10.	R10 open R12 open C5 shorted	C5 leaky	R10 very high C2 open C2 leaky C5 leaky		R6 open C5 open C7 open C7 leaky	R7 open R8 open R10 low C4 leaky C7 shorted

¹ In sets without extra (not shown) B-plus connection

Use this guide to help you pinpoint the faulty part. BE VERY SURE to clamp i.f. agc line as described in text; all indications in this chart are under those conditions.

Measure each of the five key voltages with a vtvm.

For each, move across to the column that describes the change you find.

Finally, notice which parts are repeated in the combination of changes you find.

Test those parts individually for the fault described.

WAVEFORMS AS GUIDES

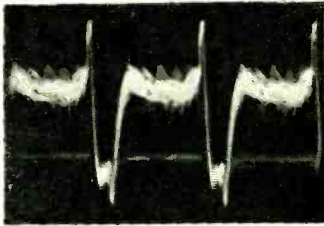

WF2 Normal 0.6V p-p

Taken at G1-pin-7, noise-canceling grid, this is video-and-sync signal directly from video detector. Sync pulses normally point negative. There is no compensating network at input, just dc-blocking capacitor C1. Note trailing edge is sharp, rather than leading edge as in WF4. This signal doesn't affect operation of tube much unless there is noise accompanying signal. In that case, noise pulse blocks conduction momentarily to keep its own counterpart from appearing in sync output (which is WF5, taken from plate-pin-8).

V p-p low	V p-p high R8 open C4 leaky C5 open	V p-p zero C2 open	 2V p-p R7 open	 3V p-p R8 open	 0.4V p-p R10 open	 0.5V p-p R12 shorted	 2V p-p C7 shorted
			 0.4V p-p C2 open	 2V p-p C2 leaky	 2V p-p C5 open	 0.6V p-p C5 leaky	 0.6V p-p C7 open

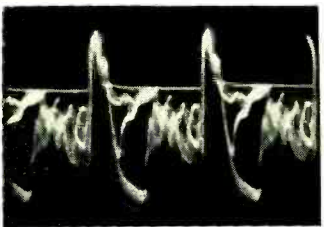

WF4 Normal 30 V p-p

Taken at G3-pin-9, this is high-amplitude signal containing video and positive-going sync pulses. It has been amplified and inverted by video amplifier before being applied to input network C6-R11-C7. Compensating network puts slope on trailing edge, leaving leading edge fairly sharp. Sync pulses in this signal are ones that drive tube, developing horizontal and vertical sync in output (taken from plate-pin-8).

V p-p low R12 shorted C5 leaky C7 open	V p-p high C2 open	V p-p zero	 20V p-p R7 open	 40V p-p R8 open	 2.5V p-p C2 leaky	 2V p-p C7 open	 40V p-p C7 shorted
--------------------------------------------------------	------------------------------	-------------------	------------------------	------------------------	--------------------------	-----------------------	---------------------------

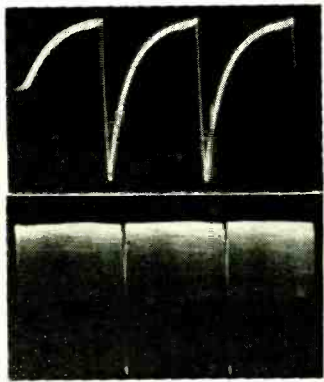

HORIZ

**WF5 Normal (H) 40 V p-p
(V) 75 V p-p**

This is output of sync separator section, taken from plate-pin-8. Scope sweep is set at V or about 20 Hz to show vertical sync output; at usual 5-kHz sweep rate for horizontal. Vertical-sync spikes are almost twice amplitude of horizontal pulses (which you can see as shading between vertical pulses). Both horizontal and vertical sync pulses are negative-going, being inverted in amplifying/separating process. Note video has been removed—that's important.

VERT

Top waveforms horizontal, bottom vertical. Vertical malfunction applies to horizontal waveforms. (see below)

V p-p high R10 open R12 open R12 shorted R13 shorted C2 leaky C4 leaky C7 open	V p-p zero C5 leaky	V p-p low R13 open ¹ C2 leaky C4 shorted	 2V p-p	 2.8V p-p	 3V p-p	 40V p-p	
		¹ In sets without extra (not shown) B-plus connection.	 20V p-p R8 open	 20V p-p R10 open	 18V p-p C2 leaky	 4V p-p C7 open	 60V p-p C7 shorted

NOTES:

Use this guide and the Voltages Guide to help you pin down fault possibilities. ALWAYS clamp the i.f. age line at whatever voltage lets video reach the TV screen, even if sync remains poor. All waveform symptoms in this chart are under those conditions (see text).

With the direct probe of the scope, check the three key waveforms. The scope should be set at H or about 5 kHz, to show three cycles of waveform. Note amplitude. If it's low or high, check parts under those descriptions. Note waveshape. If there's a change from normal, check the parts indicated.

by RAY CLIFTON

HAVING LEARNED THE BASIC THEORY OF MOSFET operation last month, you're ready to build simple circuits using some of the low-cost devices available.

If you experimented with JFET's, as outlined in the previous article (June 1969, R-E), you should have an idea of the parts you'll need for breadboarding a circuit. You might check Fig. 1 for more ideas on parts values. For ease of bread-board experimenting, I recommend a few perforated boards with push-in terminals.

Another indispensable accessory is a bias box, to furnish gate bias while you're setting up a circuit. Fig. 2 shows the simple arrangement I used—two 9-volt transistor-radio batteries across a 1-meg-ohm linear-taper pot, with a switch to save the batteries when not in use.

You'll need a power supply capable of 20 volts and about 10 mA; batteries will do. To set up circuits dynamically, you will need an audio generator. A single frequency between 400 and 2500 Hz is all you need, and output voltage can be quite low—50 mV rms. If you built the simple JFET audio oscillator shown in the June article, it will do nicely.

You should have an oscilloscope to observe waveforms, but it need have only audio-frequency response. A high-impedance electronic voltmeter (vacuum-tube or transistor) is essential, and a milliammeter is nice, but not a necessity.

In the previous article, you learned how to design a microphone preamplifier. This is just as good a starting place for MOSFET design, because it's simple and immediately useful. Assume a high-impedance crystal or ceramic microphone with an output of about 30 mV rms. Stage Q1 of Fig. 1 is representative of what you can do with a MOSFET, and here's how to design and build the circuit. I used a 40467, but the MPF157, MPF158, 40468 and 40559 would also be good choices.

Because of the high gate impedance of the MOSFET, it's wise to use 2.2 megohms for gate resistor R1. Since the circuit will be entirely MOSFET, assume roughly the same value of gate resistor for the following stage. To provide good low-frequency response with such high gate resistance, coupling capacitors C1 and C2 should be 0.1 μ F. Using .05 or even .01, however, won't cause noticeable loss of low frequencies. If you want only speech-quality response, use .005 μ F.

Drain-load resistor R2 is 100k because that's a good compromise between maximum voltage gain (A_v) and distortion. In a preamp stage you want lots of gain, and the input voltage swing is small, so 100k is about right.

The 40467 operates best with some reverse gate bias. You want to bias the source positive with respect to ground (so the gate is negative with respect to the source) This bias is developed across R3.

Previously you learned that MOSFET's must be handled carefully to avoid

permanently destroying the insulated gate. Some authorities recommend using soldering irons rather than guns. You must ground the iron tip and use heat-sink pliers on the MOSFET leads when soldering them in the circuit. But a much simpler method is to use transistor sockets. Push the socket leads through the

MOSFET's

Part 2—Circuits you can build and use

holes in a perforated board and solder the circuit components to the terminals. Be sure the gate, source and substrate terminals each have a dc return to chassis, and ground the chassis. When you have the components in place (soldered or clip-leaded) you are ready to install the MOSFET in the socket. Be sure no hot wires are near the circuit, and ground the chassis or common bus to bench ground (ideally, the earth). Then ground yourself. I work at a bench with a grounded metal molding around the edge. When I rest my forearms on the front of the bench, I am grounded through the molding. You might also try a metal sheet, and rest your elbows upon it.

If your arms are grounded, you can handle a MOSFET with impunity. Pull off the shorting ring, spread the leads with long-nose pliers, and insert the device in the socket. If it doesn't go in easily, don't push heavily on the can—you'll only bend the leads and have to straighten them out. Use your pliers to ease each lead in, one by one. Once the MOSFET is in the socket, never allow the gate terminal to float. It must *always* have a dc return path to ground, or it may build up a static voltage which will destroy it.

Once the device is in the socket, don't remove it, except to replace it. If you have to solder or unsolder a component wired to the socket, hang heat-sink pliers on the MOSFET lead itself (*not* the socket terminal). Then clip-lead the pliers to chassis ground. Don't heat the terminal any more than necessary. If you use a soldering gun (as I do) keep the tip and the tip loop away from the MOSFET.

Setting bias dynamically

The value of R3 can be determined experimentally. Connect a resistor of

Applications: Types A, B, and C FET's

In general, all type-A FET's are junctions, and all Types B and C are MOS.

Type-A FET's are preferred in the following applications:

1. As a dc amplifier, the JFET is more stable than the MOSFET.
2. As a low-noise, low-frequency amplifier.
3. As a differential amplifier.
4. As a low-drift single-ended amplifier.

Types B and C FET's are preferred in the following applications:

1. Where very high input impedance is required, as in a picoammeter or electrometer. The MOSFET has the lowest input current of any amplifying device.
2. As a low-noise hf, vhf and uhf amplifier.
3. As a vhf amplifier and converter, the MOSFET has the lowest cross-modulation of any amplifier device.
4. As a variable resistor or voltage-controlled attenuator, the MOSFET has the greatest control-to-signal isolation of any device.
5. Anywhere a device is needed which can withstand positive and negative input voltage swings without decreasing input impedance or drawing input current. The MOSFET can operate with reverse, zero or forward bias.
6. As an analog or digital switch, the MOSFET requires no offset voltage, has low on resistance, high off resistance, low capacitance and high switching speed.

7. As an extremely sensitive proximity detector. MOSFET's have extremely low input capacitance (1 to 10 pF).

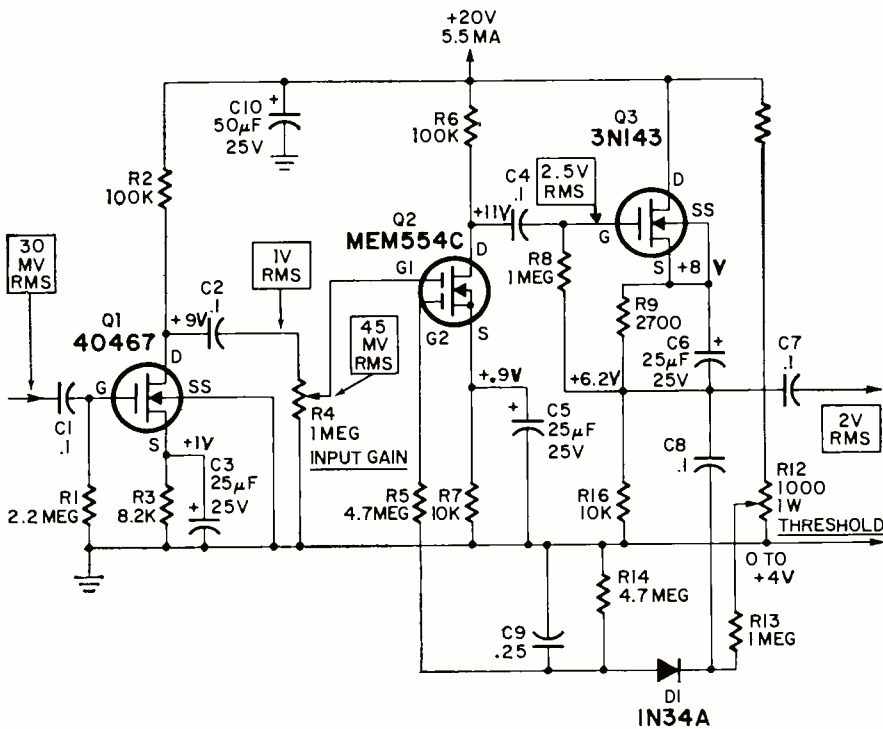
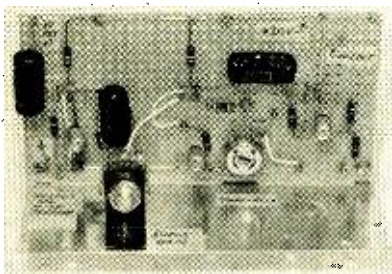

Fig. 1—MOSFET microphone preamp has agc circuit to compress signal range.



Front view of mike preamp breadboard.



Rear view of mike preamp breadboard.

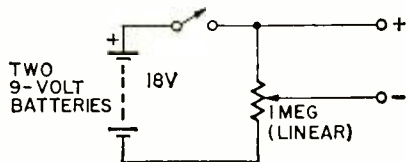

Fig. 2—Bias box for use with MOSFET's.

1000–2000 ohms in series with the bias box. If you have a milliammeter, put it in series with the box. Clip a high-impedance voltmeter from the source terminal to ground, to measure bias voltage.

Tie the power supply to R2 as shown in Fig. 1, hang a scope and a monitor amplifier across the stage output

(through C2), and feed about 30 mV rms into C1 (400 to 2000 Hz. approximately). Turn on the power supply and vary the bias-voltage setting carefully until you see a sine wave coming out of the stage. You'll find a range of bias voltages which produce a sine wave; choose a voltage that gives you maximum gain with minimum distortion. Try to get in the middle of the useful range, as this gives the circuit the most leeway against temperature and supply-voltage variations. Figure the value of source-bias resistor R3 from the current and voltage you read. If you haven't a milliammeter, compute current through your temporary R3. I found 8200 ohms necessary to bias the 40467 I used, but because of parameter spread from device to device, you may have to use another value. Ordinarily the nearest 10% resistor value will do—unless you are right in the middle between two values. In that case, use a 5% value.

Adding agc

One thing about the MOSFET—because the gate is insulated from the channel, there's nearly perfect input-output isolation. A dual-gate MOSFET is therefore a natural choice for an agc amplifier. Audio agc amplifiers are plagued by *thump*—the sound of the dc control signal, which gets into the audio path. A MOSFET can't thump, because the gate's insulated from the drain-source channel. Adding automatic gain control to the mike preamp is useful because you don't have to ride gain while making a tape recording, for instance. It has the same advantage in PA work.

The MEM554C dual-gate MOSFET makes a good agc-controlled stage; one gate accepts the audio signal, and the other the dc control signal. Gate 1 works

best with reverse bias, while gate 2 can operate with reverse or forward bias. Thus it's best to reverse bias the stage. Fig. 1 shows the circuit. Since input stage Q1 puts out about 1 volt rms, you must use a pot between Q1 and Q4. A standard value is 1 megohm, which will work in the circuit. Slightly less gate-input loading is obtainable with a 5-megohm pot. Either should be audio taper, of course.

You can again use a 100k load resistor, and temporarily ground gate 2 through a parallel combination of a 4.7-megohm resistor and any capacitor from .001 to 0.1 μ F. Set up the stage as before, using about 30–45 mV rms into gate 1. Find the value of source resistor R7 and install it.

You can omit stage Q3 if you're willing to use a high-impedance preamp output, for that stage is simply a source follower to furnish a low-impedance output. The 3N143 I used has a fairly high I_{DSS} rating, and thus will work well with a fairly low load resistance. I chose 10k for R10. To set up this source follower, insert about 1k as a temporary R9 source-bias resistor, again placing the bias box and milliammeter in series with it. Don't forget source-bypass capacitor C6: without it the stage gain will be quite low. Determine the exact value of bias needed to produce maximum undistorted output, compute the resistor, and put it in the circuit. I found about 2700 ohms about right (2820 was my calculated value).

DC feedback network

To demonstrate how controlled-stage Q2 works, tie your bias box to gate 2 of the MEM554C. *Caution:* Use a clip lead and ground the gate 2 terminal before you unhook R5 from ground. Then connect the bias-box negative terminal to R5 and the positive terminal to gate 2. Remove the temporary bypass capacitor from gate 2, set the bias to –5 volts, unshort the gate, and fire up the power supply. You'll see that varying the bias on gate 2 affects the gain of Q2. The more negative the bias, the less the gain.

Now turn off the power, short the gate 2 terminal to ground again, and reverse the bias box; connect the positive terminal to R5 and the negative terminal to ground. Unshort the gate and turn on the power supply. By varying the bias, you will see that positive gate 2 voltage increases the gain of Q2. You are enhancing the channel of the MEM554C.

I found using enhancement voltage on gate 2 a more effective means of gain control than using negative voltage. (It also produces more gain.) Here's how the dc feedback network shown in Fig. 1 works: R11 and R12 form a voltage divider from the supply to ground, and the arm of threshold control R12 can be set from 0 to +4 volts. R13 is an isolating resistor between D1 and the bias source. The positive voltage from the arm of R12 reverse-biases D1. Resistor R5 isolates the gate from the rest of the circuit, preserving its high impedance value.

Audio signals through the preamp are coupled through C8 to the cathode of D1, which conducts, adding a nega-

tive dc voltage to gate 2 of Q2. In other words, audio through C8 causes the bias on gate 2 to be *less positive*, which decreases stage gain. If the audio signals increase, so does the negative dc produced by D1, which reduces the gain of Q2 still more.

Of course, you can't use a constant-amplitude sine-wave oscillator to check out an agc stage. You'll have to use a varying-amplitude signal. Best is a live microphone or a tape recording of uncompressed speech. You *can* use a commercial disc or tape recording or the signal from a receiver, but they'll contain some compression and/or limiting, which will tend to smooth out their amplitude variations.

Whatever source you use, couple it to the input and set the level carefully, to avoid overdriving input stage Q1. Tie a high-impedance voltmeter to the point between D1 and R5 to monitor gate bias on gate 2. Use the scope on the output to monitor the waveform and check audio output level. Vary the setting of R12 until you get the compression you want.

Resistor R14 and C9 set the time constant of the control line, which is about 1 sec. This provides for rather slow overall gain control, which is what an agc or compressor amplifier should have. If you want a faster time constant, simply change the values of C9 and R14. Use the formula $T = RC$, where T is time in seconds, R is resistance in megohms and C is capacitance value in microfarads.

Voltage-variable attenuator

The input-output isolation of the MOSFET makes it ideal as a noiseless attenuator, which has no coupling between the controlling and the controlled circuits. As you saw last month, the ohmic region of a MOSFET transfer curve shows a rapid change in I_D with a variation in V_{GS} . In this region of the curve, channel resistance changes abruptly from a few hundred ohms to several megohms. In other words, by applying a variable dc voltage to the gate, you can control drain-source resistance.

Fig. 3 shows the circuit of a simple shunt MOSFET attenuator in gate circuit of a JFET common-source stage. The amplifier is conventional and follows the principles outlined in the previous article.

Attenuator Q1 should be used at a point with no less than about 150 mV rms; otherwise, series resistor R1 will degrade signal-to-noise ratio. Mount Q1's socket with the drain terminal as close as possible to the gate terminal of the following stage (Q2, in this case). If you don't do this, you may get undesired stray pickup at the amplifier gate. Likewise, mount R2 close to Q1's gate terminal, so that it properly does its job of isolating the gate and preserving its high impedance.

A simple way of providing the required dc control voltage for the gate of Q1 is to use batteries. You can then realize the great advantage of this circuit. You can put the pot and batteries at almost any distance from the amplifier,

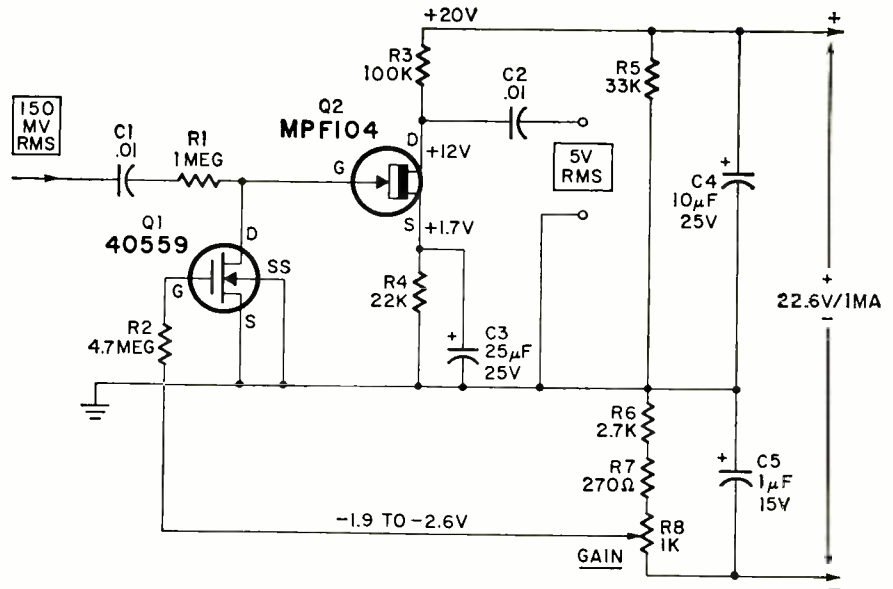

Fig. 3—MOSFET voltage-variable attenuator for use as a remote volume control.

with no detriment to amplifier gain or frequency response.

An alternate method, however, is what I chose for my breadboard circuits; I put a voltage divider across the supply. This method is perhaps even simpler, because you need only a pot and three-wire line at the remote location. Here's how to determine the values of the divider resistors.

Since you have no way of knowing the location of the ohmic region of the transfer curve on the particular MOSFET you use (due to parameter spread) you must determine it dynamically. (I used a 40559 MOSFET, but almost any n-channel Type-B device could be used.) Connect Q1, R1 and R2 in the circuit. Then connect R8, a 1000-ohm linear pot, across a 5-volt source. Tie the arm of R8 to R2.

Bias the MOSFET gate to -5 volts and feed a sine wave through the circuit. Use a scope to monitor the output so you can see the change in gain. Hang a voltmeter (any impedance) from the arm of R8 to chassis. Vary the setting of R8 and watch the scope. Record the voltmeter reading at the point just past where the sine wave is completely unattenuated (maximum gain). Then do the same for the maximum attenuation point. In my case, these two readings were -2.0 and -2.6 volts.

Since you are using a 1000-ohm pot, and you want a variation of 0.6 volt across it, Ohm's law calls for 0.6 mA to flow through the divider. Now you know the current value, and the drain supply for Q2 must be 20 volts, so R5 must be 33k. Resistor R8 must vary the bias from -2.0 to -2.6 volts, so you need a 2-volt drop between ground and the pot. By Ohm's law, this is 3300 ohms. I tried this value and found a range of -2.3 to -3.0 volts across R8. Then I tried 2700 ohms for the dropper and found a range of -1.7 to -2.4 volts. Probably my resistors were off just enough to spread the ranges. At least I had bracketed the range I wanted. I then used a 2700-ohm and a 270-ohm (10%) in series (R6 and



Front view of attenuator breadboard.

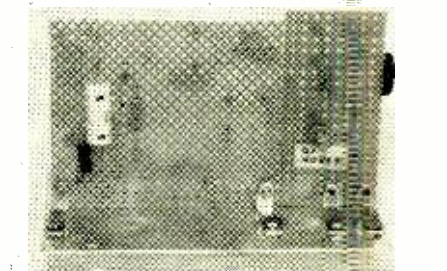

Rear view of attenuator breadboard.

R7), and got a range of -1.9 to -2.6 volts, which worked out just fine. Attenuation is spread across the entire range of the pot.

To preserve isolation between the dc control circuit and the audio signal path, be sure to use two filter capacitors, C4 and C5, instead of a single one across the supply. Note that the supply floats across the chassis. At the light load of 1 mA, a 212.5-volt battery (NEDA 215) would work just fine.

455-kHz generator

This device is simple and has but one purpose—to furnish unmodulated output of 455 kHz for AM receiver i.f. alignment. (You don't need modulation because your readout indicator should be a voltmeter across the receiver *avg* line. And you don't need other frequencies; align the front end on BC stations.)

(continued on page 68)

One of our students wrote this ad!

Harry Remmert decided he needed more electronics training to get ahead. He carefully "shopped around" for the best training he could find. His detailed report on why he chose CIE and how it worked out makes a better "ad" than anything we could tell you. Here's his story, as he wrote it to us in his own words.

By Harry Remmert

AFTER SEVEN YEARS in my present position, I was made painfully aware of the fact that I had gotten just about all the on-the-job training available. When I asked my supervisor for an increase in pay, he said, "In what way are you a more valuable employee now than when you received your last raise?" Fortunately, I did receive the raise that time, but I realized that my pay was approaching the maximum for a person with my limited training.

Education was the obvious answer, but I had enrolled in three different night school courses over the years and had not completed any of them. I'd be tired, or want to do something else on class night, and would miss so many classes that I'd fall behind, lose interest, and drop out.

The Advantages of Home Study

Therefore, it was easy to decide that home study was the answer for someone like me, who doesn't want to be tied down. With home study there is no schedule. I am the boss, and I set the pace. There is no cramming for exams because I decide when I am ready, and only then do I take the exam. I never miss a point in the lecture because

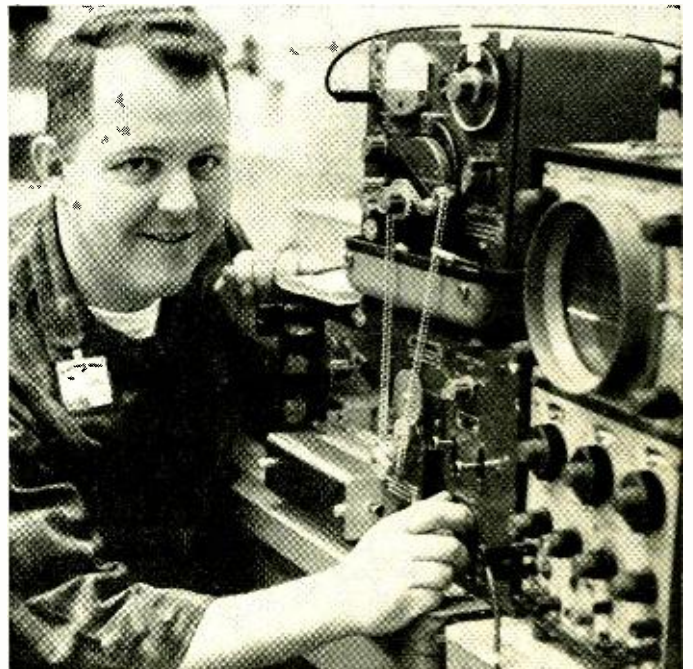

Harry Remmert on the job. An Electronics Technician with a promising future, he tells his own story on these pages.

it is right there in print for as many re-readings as I find necessary. If I feel tired, stay late at work, or just feel lazy, I can skip school for a night or two and never fall behind. The total absence of all pressure helps me to learn more than I'd be able to grasp if I were just cramming it in to meet an exam deadline schedule. For me, these points give home study courses an overwhelming advantage over scheduled classroom instruction.

Having decided on home study, why did I choose CIE? I had catalogs from six different schools offering home study courses. The CIE catalog arrived in less than one week (four days before I received any of the other catalogs). This indicated (correctly) that from CIE I could expect fast service on grades, questions, etc. I eliminated those schools which were slow in sending catalogs.

FCC License Warranty Important

The First Class FCC Warranty* was also an attractive point. I had seen "Q" and "A" manuals for the FCC exams,

*CIE backs its FCC License-preparation courses with this famous Warranty: graduates must be able to pass the applicable FCC License exam or their tuition will be refunded in full.

and the material had always seemed just a little beyond my grasp. Score another point for CIE.

Another thing is that CIE offered a complete package: FCC License and technical school diploma. Completion time was reasonably short, and I could attain something definite without dragging it out over an interminable number of years. Here I eliminated those schools which gave college credits instead of graduation diplomas. I work in the R and D department of a large company and it's been my observation that technical school graduates generally hold better positions than men with a few college credits. A college degree is one thing, but I'm 32 years old, and 10 or 15 years of part-time college just isn't for me. No, I wanted to *graduate* in a year or two, not just *start*.

If a school offers both resident and correspondence training, it's my feeling that the correspondence men are sort of on the outside of things. Because I wanted to be a full-fledged student instead of just a tagalong, CIE's exclusively home study program naturally attracted me.

Then, too, it's the men who know their theory who are moving ahead where I work. They can read schematics and understand circuit operation. I want to be a good theory man.

From the foregoing, you can see I did not select CIE in any haphazard fashion. I knew what I was looking for, and only CIE had all the things I wanted.

Two Pay Raises in Less Than a Year

Only eleven months after I enrolled with CIE, I passed the FCC exams for First Class Radiotelephone License with Radar Endorsement. I had a pay increase even before I got my license and *another* only ten months later. I'm getting to be known as a theory man around work, instead of one of the screwdriver mechanics.

These are the tangible results. But just as important are the things I've learned. I am smarter now than I had ever thought I would be. It feels good to know that I know what I know now. Schematics that used to confuse me completely are now easy for me to read and interpret. Yes, it is nice to be smarter, and that's probably the most satisfying result of my CIE experience.

Praise for Student Service

In closing, I'd like to get in a compliment for Mr. Chet Martin, who has faithfully seen to it that my supervisor knows I'm studying. I think Mr. Martin's monthly reports to my supervisor and generally flattering commentary have been in large part responsible for my pay increases. Mr. Martin has given me much more student service than "the contract calls for," and I certainly owe him a sincere debt of gratitude.

And finally, there is Mr. Tom Duffy, my instructor. I don't believe I've ever had the individual attention in any classroom that I've received from Mr. Duffy. He is clear, authoritative, and spared no time or effort to answer my every question. In Mr. Duffy, I've received everything I could have expected from a full-time private tutor.

I'm very, very satisfied with the whole CIE experience.

ENROLL UNDER NEW G.I. BILL

All CIE courses are available under the new G.I. Bill. If you served on active duty since January 31, 1955, or are in service now, check box on reply card or coupon for G.I. Bill information.

Every penny I spent for my course was returned many times over, both in increased wages and in personal satisfaction.

Perhaps you too, like Harry Remmert, have realized that to get ahead in Electronics today, you need to know much more than the "screwdriver mechanics." They're limited to "thinking with their hands"...learning by taking things apart and putting them back together...soldering connections, testing circuits, and replacing components. Understandably, their pay is limited—and their future, too.

But for men like Harry Remmert, who have gotten the training they need in the fundamentals of Electronics, there are no such limitations. As "theory men," they think with their heads, not their hands. For trained technicians like this, the future is bright. Thousands of men are urgently needed in virtually every field of Electronics, from two-way mobile radio to computer testing and troubleshooting. And with this demand, salaries have skyrocketed. Many technicians earn \$8,000, \$10,000, \$12,000 or more a year.

Send for Complete Information—FREE

Many men who are advancing their Electronics career started by reading our famous book, "How To Succeed In Electronics." It tells of the many electronics careers open to men with the proper training. And it tells which courses of study best prepare you for the work you want.

If you're "shopping around" for the training you need to move up in Electronics, this 44-page book may have the answers you want. We'll send it to you FREE. With it, we'll also include our other helpful book, "How To Get A Commercial FCC License."

To get both FREE books, just fill out and mail the bound-in postpaid card. If the card is missing, send the coupon below.

CIE Cleveland Institute of Electronics

1776 East 17th Street, Cleveland, Ohio 44114

Accredited Member National Home Study Council • A Leader in Electronics Training... Since 1934



NEW COLLEGE-LEVEL COURSE IN ELECTRONICS ENGINEERING

for men with prior experience in Electronics. Covers steady-state and transient network theory, solid state physics and circuitry pulse techniques, computer logic and mathematics through calculus. A college-level course for men already working in Electronics.

Cleveland Institute of Electronics
1776 East 17th Street, Cleveland, Ohio 44114

Please send me without cost or obligation:

1. Your 44-page book "How To Succeed In Electronics" describing the job opportunities in Electronics today, and how your courses can prepare me for them.
2. Your book on "How To Get A Commercial FCC License."

I am especially interested in:

- | | |
|--------------------------------------------------|----------------------------------------------------------------|
| <input type="checkbox"/> Electronics Technology | <input type="checkbox"/> Electronic Communications |
| <input type="checkbox"/> Broadcast Engineering | <input type="checkbox"/> Industrial Electronics and Automation |
| <input type="checkbox"/> First-Class FCC License | <input type="checkbox"/> Electronics Engineering |

Name _____ (PLEASE PRINT)

Address _____

City _____

State _____ Zip _____ Age _____

Check here for G.I. Bill information. RE-67

Circle 31 on reader service card

MOSFETS

(continued from page 63)

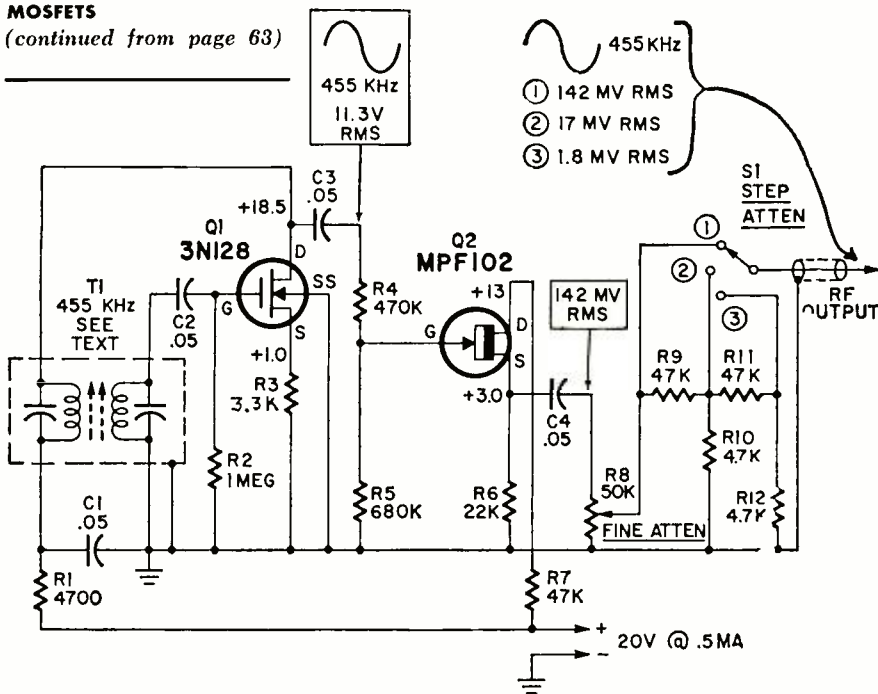
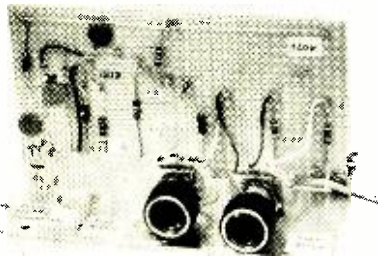
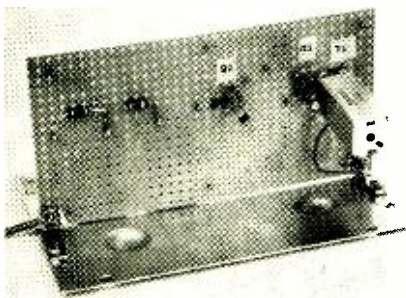

Fig. 4—MOSFET 455-kHz generator is variation of tuned-plate, tuned-grid oscillator.



Front view of 455-kHz generator board.



Rear view of 455-kHz generator board.

I didn't use a crystal because it's expensive and unnecessary. You can zero-beat the second harmonic of this generator with a BC station on 910 kHz and end up very close to 455.

Winding a coil and juggling L and C values can be a tiresome job. Besides, hundreds of 455-kHz i.f. transformers are thrown away with old vacuum-tube radios every week. Such hi-Z cans match FET's nicely.

Fig. 4 shows the circuit I used. It's a variation of the tuned-plate, tuned-grid oscillator. In the classic TPTG, the two tank circuits aren't coupled; here they are, but this only provides more feedback.

If you must buy an i.f. can, find out how it's supposed to be connected.* If

you cannibalize an old fire-bottle chassis, note how the can was wired in. You want to tie the *plate winding* to the *drain circuit* of Q1. Then you want to tie the *grid winding* to the *gate circuit* of Q1. One big difference between the original i.f. hookup and this one: Reverse connections from *one* winding, so the gate circuit gets positive feedback.

The MOSFET makes an excellent oscillator. Its high impedance means you can use vacuum-tube circuits with little or no change. The small mass of the MOSFET allows it to warm up fast. Its thermal and frequency stability is very good. I used a 3N128, but the 3N143 and 3N152 will also work well.

Resistor R1 and C1 decouple Q1 from Q2 and the power supply. (None of the capacitor values here are critical; I used .05's because they have an X_c of 7 ohms at 455 kHz and I had some discs of that value. Don't use tubulars; they have more L than discs.)

Start with about 1k for R3 until you get the oscillator going. Then hang a scope across a 1-meg load resistor in place of R4 and R5. Adjust the value of R3 for the purest sine wave and highest output you can get. You'll have to compromise, but remember you only want a little second harmonic (910 kHz) and no higher orders in the output.

As the diagram shows, I got about 11.3 volts rms out of the oscillator. If you use this much rf you'll overload an i.f. strip. Besides, you can't couple the oscillator to the i.f. strip without detuning it. What you need is an isolation amplifier.

Almost any JFET or MOSFET could be used as Q2, which is merely a buffer stage. I chose the MPF102 because it has a high y_{fs} rating. Also suitable are the 2N5163, MPF105, 2N3819 and TIS-

*Any of these will work: Lafayette 32 T 0946, Meissner 16-6758, Miller 12-C1 or Vidair 119-67-09.

34 low-cost, MOSFET devices.

The 11.3 volts of rms from Q1 will overdrive Q2, so you'll need a divider in the gate circuit. Use a 1-meg pot temporarily. Strap in the values shown for R6 and R7, and don't forget C4 and R8 as a load. Then juggle the values of drain load R7, source load (and bias) R6, and the setting of the gate pot. You may not get a perfect sine-wave output from Q2, but try for the least distortion with fairly high output: 100-200 mV rms are all you really need for i.f. alignment purposes.

When you tie down the variables, install fixed resistors. Unhook the temporary gate pot and measure the arm-to-end resistances on an ohmmeter. Then select the nearest 10% values, making the total of R4 and R5 approximately 1 megohm. If R5 is less than 470k, use a larger R_T of 2 megohms. (You want to keep the gate of Q2 at a fairly high impedance.)

Don't bypass R7 in Q2's drain circuit; it provides degeneration which keeps the output linear. And don't take output from the drain circuit. The source-coupled output isolates the load from the oscillator more effectively.

The step attenuator gives approximately 10:1 decade attenuation. The fine attenuator lets you adjust for any value in between.

Be sure you build this generator in a metal box, but leave two holes for the transformer slugs, so you can zero-beat the oscillator every now and then.

General notes

The above procedures and circuits are, of course, merely an introduction to MOSFET circuits. For better performance and more complex circuits, obtain manufacturers' literature and study device characteristics more closely.

More advanced circuits using MOSFET's include vhf oscillators, rf amplifiers and mixers, where the device performs excellently due to its low noise figure and minimum cross-modulation. Because of its extremely high input impedance, the MOSFET also does an excellent job in a picoammeter circuit. It is additionally good as an rf switch, pulse generator and Wien-bridge oscillator.

Already FET's are being modified for even more sophisticated circuits. A few photoFET's are available which generate current when exposed to light. And MOSFET's are being fabricated in the inputs of IC's, where their high input impedance is of special value.

It looks like you'll be seeing a lot of FET's in the years to come. **R-E**

References

FET Applications Handbook, J. Eimbinder. Ed. Tab Books. Blue Ridge Summit, Pa.; 1967. \$12.95.
FET Principles, Experiments, and Projects, by Edward M. Noll. Howard W. Sams & Co., Inc., Indianapolis, Ind.; 1968. \$4.95.
MOSFET in Circuit Design, by Robert H. Crawford. McGraw-Hill Book Co., Inc., New York, N.Y.; 1967. \$10.00.

CAREERS IN ELECTRONICS

By **BYRON G. WELS**

TECHNOLOGICAL PROGRESS COUPLED with automation continues to eliminate unskilled jobs while creating an unprecedented demand for people with the background to design, test and service complex new equipment.

Today's \$20 billion electronic industry is expected to double in dollar volume in the next 10 years. How can you become a part of this growth?

Electronic aptitude

You might save a great deal of time and money pursuing a career field to which your abilities are not suited by first asking yourself, "Do I have the aptitude for a career in electronics?"

Each year, for example, a large percentage of the first year class at technical and engineering schools "drop out." Many of them have an interest in electronics, but quickly find this motivation is not enough to overcome a lack of needed technical and mathematical aptitudes.

You might avoid disappointment and needless expense by first arranging to take a battery of aptitude tests through high school guidance counselors, state employment agencies or the psychology department at a local college. Many schools give preliminary aptitude tests to applicants.

Training and education

Once you've set your sights on a career in electronics, there are many paths to your goal. First, the demand for personnel in the electronics industry is so great today, that firms have established on-the-job training programs and hire trainees without prior experience. Job training is coupled with classes in electronics, and tuition refunds are offered to permit further study through correspondence courses

or at night school.

What about self study? Bookstores can provide study material covering basic electronics, but this approach demands considerable self discipline and motivation. Due to the diversity and growing complexity of the field, it's becoming more and more difficult to organize a worthwhile self-study program. Employers prefer some evidence of formal study—a degree or certificate.

Military training not only offers a means of obtaining electronic skills but can be a rewarding career in itself. Increasingly, the armed forces are recognizing the importance of career-oriented personnel and are rewarding them accordingly. Many civilian electronics technicians and engineers began their careers in military electronics, furthering their education later under the GI Bill.

Two-year technical schools offer

excellent training. Proprietary or private schools, the best of which require high school graduation for admission, stress theory and equipment training. Many have night school and correspondence programs. A growing trend in technical education is the community college or public institute. These two-year schools offer Associate of Applied Science degrees, and program humanities courses that private technology schools usually do not include.

Correspondence courses have the advantage of letting you set your own study pace. Study material is prepared by experts and you receive professional guidance through the mail. Most of the larger schools offer sequences in several areas, such as radio/TV, computers, industrial electronics, communications, etc.

A B.S. degree in electrical engineering is generally required to become an electronics engineer, although

Photo courtesy Martin Marietta

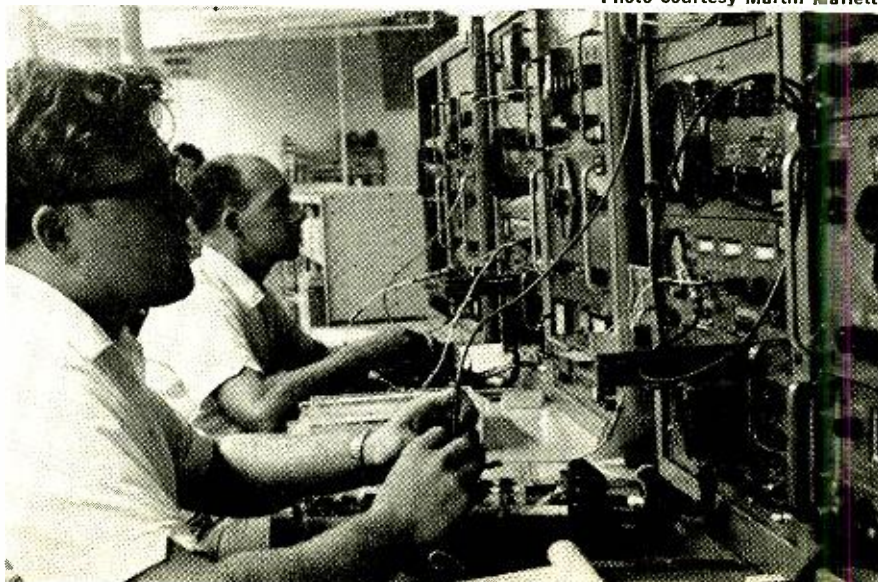

there are other means: Federal and state civil service boards set training and educational requirements for professional engineer ratings, as does the IEEE. Some companies assign engineering titles to employees without B.S. degrees. (Salaries, however, do not necessarily correspond to titles, and skilled technicians sometimes earn more than engineers.)

Industrial electronics

Industry is disparate for trained men at all levels, from engineers on down. Work in industrial electronics is widely diversified, depending on the field you choose, and the areas in which you are interested. You'll find openings for production and production control people, where the concentration is one of selecting areas of mass production suitable for automation, and the design and implementation of this automated equipment. Where automation is not feasible, studies are made to break the work down in stages that can be most easily handled by a given group of workers.

The quality control group concentrates its efforts in seeing that the company product is up to required standards and specifications. This is done by a series of tests on the product with sophisticated test equipment. The Q/C operators must be thoroughly familiar with the use of meters, oscilloscopes, and related equipment.

Maintenance men keep the exotic test equipment used in the lab and shop in peak working condition. They see to it that laboratory standard equipment is well-calibrated by periodic checks, and remove equipment to the maintenance shop on a routine basis, for clean-up and test. No product is ever more accurate than the equipment used to test and align it, so the laboratory maintenance crew does a critical and important task.

But probably the most interesting work goes on in the research and development lab. Here, the prototype equipment is built, that starts with a basic idea, and comes out completed and packaged. Here an engineer works up his diagrams, and turns them over to a lab technician. Consulting with the engineer, they come up with a breadboard model for preliminary testing. Then a finished unit is assembled.

Along with all of this, the industrial field offers such other tasks as writing technical manuals, preparing blueprints and drawings, and even technical electronic photography, a field in itself!

Career in communications

Today, more than ever before,



Photo courtesy Martin Marietta

communications is coming into its own in a big way. What with transatlantic signals being bounced off echo satellites, with space pioneers depending on communications with the ground, technology is becoming more and more crucial every day. Without communications nothing can move, whether it's a business radio installation in a fleet of oil trucks to an elaborate intercontinental radio telephone system. This equipment must be manufactured, installed, and maintained.

Communications goes even further. A part of this vast complex includes ship-to-shore radio phones, and a vast array of accessory equipment for ships of all sizes, including radar systems, depth sounders, and a complex network of radio navigational equipment both on ship and ashore.

Closely related to this are the necessary communications and accessory equipment used by the air services. These include multi-frequency transceivers, coupled with Omnidirectional transponders. The omni system brackets the nation, with stations spread overland to form a network of high-

Photo courtesy RCA



ways in the sky. Along with these, one finds the distance-measuring equipment, weather radar, auto pilot systems, radio altimeters, and other electronic devices necessary to assure the safe completion of every flight. You also find an elaborate complex of communications equipment on the ground as well, with most major facilities offering radar and control transceivers, and even the smallest airports equipped with Unicom transceivers to provide pilots with landing information.

Career in broadcasting

The appeal in broadcasting is usually one that permits you to rub shoulders with celebrities. If you plan to break into this highly competitive field, you will probably start, as most of those who are successful in this field did, at a small radio station out in the hinterlands. In a small station, you do double-duty. Your day might begin at five in the morning, when you turn on the transmitter, and sleepily make the morning identification. You might then read the early news, and run a DJ show for a while. But to do these things, you must have an FCC license!

Many of today's top disc jockeys still proudly retain their second-class commercial tickets!

In television, you can go into audio work, camera work, and even make it in the control room.

Career in servicing

Do you like dealing with the public? Do you enjoy meeting people? Perhaps a career in radio and television repair is your dish.

The basic philosophy here is that a set worked once, then something went wrong, and it stopped. Fix what went wrong, and the set will work again until something else goes wrong. The radio/TV service technician knows how to find what's wrong quickly and correct the trouble.

In the larger repair facilities, two types of technicians are employed. The "outside" man is skilled in dealing with people, and making minor, emergency repairs. He can do the small alignment jobs, install antennas, change tubes. But when he runs into a set with really tough problems that require some fancy test equipment or a major repair, he takes the set into the shop for the "bench" man to work on.

The bench man stays in the shop, is usually a highly skilled technician. He works behind the scenes. When something goes wrong that the outside man can't fix, the bench man gets the job. He restores the set to factory specifications, and then the outside man returns it to the customer. R-E

Now there is a better Color-Bar Generator for your servicing work



THE RCA WR-502A.

New ... solid state ... battery or AC operated ... portable, weighing only four pounds.

The RCA WR-502A "CHRO-BAR" color-bar generator provides *six* separate test signals: color bars, dots, cross-hatch, vertical lines, horizontal lines, and blank raster.

The sound carrier, pattern, RF output, and color subcarrier are all crystal controlled. Designed for exceptional stability with no flicker.

Included as part of the package — at no extra cost — is an AC adaptor for line operation. This unit was formerly available only as an accessory at a cost of \$9.00*.

The new CHRO-BAR Generator WR-502A, complete with separate AC adaptor — now only \$148.50*.

RCA Electronic Components,
Harrison, N. J. 07029.

* Optional Distributor resale price.



NEW FINCO®

HOME ENTERTAINMENT
DISTRIBUTION WIRING SYSTEM
FOR DO-IT-YOURSELFERS



Everything needed to wire your home for multiple set reception – in easy-to-handle kit form.

MODELS:
HWK-75
75 ohm
HWK-300
300 ohm

- FM/FM Stereo
- For Color TV – UHF/VHF

Turn your whole house into a home entertainment center. Operate up to four sets, or be able to move your entertainment equipment from room to room. Kit includes all necessary parts, fittings and instructions.



THE FINNEY COMPANY

34 W. Interstate St., Dept. RE-12
Bedford, Ohio 44146

Please send free brochure 20-520 on FINCO HOME TV DISTRIBUTION KIT.

Name _____

Address _____

City _____ State _____ Zip _____

Circle 33 on reader service card

COMING NEXT MONTH

JANUARY 1970

- **Add Automatic Tint Control**
Magnavox has come up with a new kind of automatic tint control. Here's how to add that circuit to your set.
- **Protect Against X-Rays**
Here's a simple circuit to add to most any set with a shunt regulator. It shuts down the high voltage if the regulator fails.
- **Inside The New Color Tubes**
This year the color picture tube is changing. See what's happening and how it may affect your picture.
- **IC Color Pattern Generator**
To set up a color TV you must have a pattern generator. Here's a small portable unit built with IC's. Make one for yourself.
- **New Color TV Circuits**
Take the grand tour of color TV circuits. See the new ones and discover how they work.

Grantham School of Engineering RE-12-69

1505 N. Western Ave., Hollywood, Calif. 90027

Please mail me your free Bulletin, which explains how the Grantham educational program can prepare me for my Associate in Science Degree in Electronics Engineering.

Name _____ Age _____

Address _____

City _____ State _____ Zip _____

I am interested in: Daytime-Residence
 Supplemented-Correspondence. Home-Study



Grantham School of Engineering

has conferred on

John Doe

the degree of

Associate in Science in Electronics Engineering

with all the rights and privileges thereunto appertaining. In witness thereof this diploma duly signed has been issued by the School Administration upon recommendation of the faculty at the School on this



first day of October, 1968

D.J. Grantham
President

E. Miller
Acting Dean



Grantham School of Engineering

has conferred on

John Doe

the degree of

Bachelor of Science in Electronics Engineering

with all the rights and privileges thereunto appertaining. In witness thereof this diploma duly signed has been issued by the School Administration upon recommendation of the



faculty at the school on this sixth day of December, 1968

D.J. Grantham
President

H. A. Deany
Dean

Grantham School of Engineering



1505 N. Western Ave.
Hollywood, Calif. 90027

Telephone:
(213) 469-7878

Three Big Steps

to Success...

in

**ELECTRONICS
ENGINEERING**

There they are — three big steps that lead electronics technicians to *greater success* — three deliberate steps to *greater recognition* and *more income*. Your future is shaped by the moves you make — by the steps you take. Begin now with Step #1.

STEP #1 is a simple request for full information on the Grantham Electronics Degree Program. You take this first step by filling out and mailing the coupon. Then, we mail our catalog to you; we do not send a salesman.

STEP #2 is earning your Associate in Science Degree in Electronics Engineering (the ASEE). If you have completed at least one year of fulltime experience as a bona fide electronics technician, you may earn your ASEE Degree almost entirely by correspondence — including a minimum resident attendance of only two weeks.

STEP #3 is earning your Bachelor's Degree in Electronics Engineering. Upon completion of either the home-study or resident program leading to your ASEE Degree, you may have reached your objective, or you may wish to continue and earn your BSEE Degree. The BSEE Degree program is offered in evening classes (two evenings a week) in Hollywood, and is designed especially for employed electronics engineering technicians who hold the ASEE Degree.

Accreditation and G.I. Bill Approval

Grantham School of Engineering is accredited by the Accrediting Commission of the National Home Study Council, is approved to offer its home-study and resident courses under the G.I. Bill, and is legally authorized to grant academic degrees.

Home-Study and Resident Programs

The Grantham ASEE Degree curriculum is offered by *home study* (plus a two-week seminar in Hollywood) to *experienced electronics technicians*. However, the home-study program is not available to beginners. The ASEE-Degree *resident* program, on the other hand, is *available to beginners* and is offered in Hollywood and Washington, D.C.

In addition to the home-study and resident programs leading to the ASEE Degree, Grantham also offers a combination program (referred to as Supplemented-Correspondence), in which the student attends the School (in Hollywood or Washington) one evening per week and does the remainder of the work by correspondence.

For a free Bulletin describing the Electronics Degree Program in which you are interested, just complete the coupon at the top of this page, and mail it to the School.

FIVE MINUTE MICROPHONE HOUSING

Fellows who like to build their own mikes from mike cartridges will find that some auto ashtrays are just about made to order for the purpose. These all-metal ashtrays sell for around 35c at Western Auto and Sears, Roebuck stores, and they will accept mike cartridges up to 1 5/8 inches in diameter.

The drawing gives complete details for assembly and wiring. I used a Lafayette Radio crystal mike cartridge 1 1/2 in. in diameter. To shield the cartridge, the ground lead and the cable shield should both be soldered to the cord protecting spring or to the inside of the metal tray, as

shown. To make it easy to solder the 5/8-27 coupling ring to the bottom of the tray, scrape the enamel off the

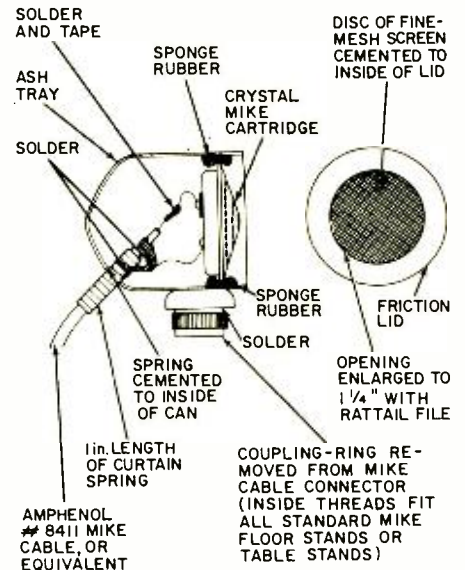

bottom of the tray and file the chrome or nickel plating off the coupling ring at the places to be soldered.



A photo shows the completed mike with the friction lid removed. The mike cartridge is held in the tray

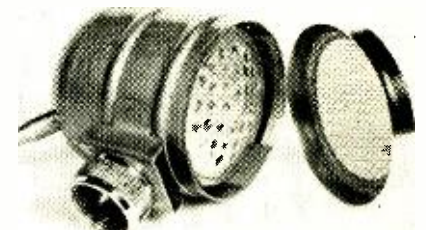

with three or four small pieces of sponge rubber. The opening in the friction lid has been enlarged with a



rat-tail file, and a disc cut from fine-mesh wire screen has been cemented to the lid.—Art Trauffer R-E

The Ins and Outs of FET's.



New Silent Partner Model 162 FET Transistor Analyst...Fastest Method of Checking Transistors In-Circuit/Out-Of-Circuit.

B&K has done it again! We've made the ins and outs of transistor analysis the fastest, most streamlined operations ever.

Now, for the first time, you can accurately check both bi-polar and FET transistors in-circuit or out-of-circuit, using the same simple testing procedure. It's like having an entire electronics laboratory in one compact package!

The Model 162 checks DC Beta from 1 to 5,000! Gm readings to 50,000 umhos. It checks FET's for Gm, I_{gss}, and I_{oss} leakage. And tests gates 1 and 2 separately. Regular transistors are checked for Beta gain, I_{CEO}, I_{CES} and I_{CE0} leakage. Unique DC injection provides more accurate in-circuit tests in low-impedance circuits. A flick of the switch tells you if an unknown

transistor is NPN or PNP type. Special safety circuits protect the Model 162 from internal damage even if wrong settings or leads are used.

All this comes complete with a concealed-handle compartment with storage and protection for test leads. A flip-top, programmed guide speeds and simplifies testing with B&K's exclusive step-by-step instructions.

Why not contact your nearest B&K distributor for complete details on how the 162 can show you the ins and outs of transistor servicing. In time and work saved, the Silent Partner Model 162 will be a real profit booster!

FET Transistor Analyst Model #162. Net: \$99.95.

Product of Dynascan Corporation
1801 W. Belle Plaine
Chicago, Illinois 60613

B&K puts an end to test equipment. We've developed Silent Partners.



Circle 35 on reader service card

1969 ANNUAL INDEX

RADIO-ELECTRONICS January-December 1969 of Vol. 40

A		Turn		Detector, superregenerative (Tech topics)	
ABC's of circuit breadboarding (Ashe)	Nov 62	Backup indicator and (NC) Signal, 1—2—3 sequential (Nunley)*	Apr 95; Carr Apr 38	Oct 69	Oct 68
ABC's of transistors (Sylvania Technical Staff)					Feb 35
Circuits and power supplies	May 66	B		Etched circuits, how to make (Gupton)	Mar 37
Test transistors fast	Feb 60	Bandpass filter, active (Tech topics)†	Oct 68	Jun 23	Jan 54
Transistor stages, how to check	Jan 56	Beginner's dot-bar generator (Goldberg)*	Jan 50	Flip-flops, how the J-K (Geisler)	
VDR's and thermistors	Apr 55	Bongos, electronic (Jaques)*	Jul 42	Frequency counter, digital RTL (Botos)*	Aug 23, Sep 52
Add electronic ignition to your car (Goldberg and Wilkins)*	Apr 32	Brains of Automation (Dietrich)	Feb 51	IC, for shutterbugs (Free)	Feb 39
Advances in automotive electronics (Holder)	Apr 48	Breadboarding, ABC's of circuit (Ashe)	Nov 62	Liquid-level indicator (NC)	May 90
Agc section (Kwik-fix charts)	Nov 37	Burned-out light indicator, auto (NC)	Jul 95	Logic circuits, IC (Lancaster)	May 32
Alarm(s)		Burst amplifier (Kwik-fix charts)	Oct 45	Motiondizer (ER)	Feb 75
Fire detector (Tech topics)†	Aug 41	Buyer's guide to 1969 color sets (Buckwalter)	Jan 42	Ovonic's, all about (Shunaman)	May 41
Intruder—fire, smoke, burglary (Steckler)	Jul 33	C		Phones, IC's in today's pushbutton (Steckler)	Jun 58
Warble-tone generator (NC)	Apr 95	Capacitors, check with pf Meter-Mate (Miller)*	Feb 57	Readouts, experiment with digital (Ashe)	Aug 47
All about IC's (Hibberd)		Careers in electronics	Dec 69	Rf circuit protection (Math)	Aug 45
Making circuit components	Jul 58, Aug 64	Cars—see Automotive electronics		SCR circuits, 20 you can make (Marston)	Jun 49
What makes them tick (Hibberd)	Jun 33	CB		Semiconductors—see specific names	
All about ovonics (Shunaman)	May 41	Gear, what's new in 5-watt (Buckwalter)	May 48	Technical topics (Scott)	Aug 41, Oct 63
Alphanumeric fun box with a Nixie (Greenberg)*	Mar 56	Troubleshooter's Casebook Feb 77; Jun 86; Jul 76; Aug 85; Oct 82	Nov 73	Timer, 45 minute (Tech topics)†	Aug 42
Amplifiers, audio—see Audio—Stereo—High fidelity, amplifiers		Channel separation nomograph (Applebaum)	Nov 73	Tools for (Hasselt)	
Antenna(s)		Chemicals—secret weapon in your shop (Coronado)	Nov 60	Pliers and cutters	Sep 39; Oct 59
Broadcast, low-noise (NC)	Mar 94	Circuit breadboarding, ABC's of (Ashe)	Nov 62	Screwdrivers	Nov 45; Dec 44
Color TV, new for (Steckler)	Sep 23	Circuits and power supplies	Nov 62	Trans-relay (NC)	Feb 96
Rotators, solid-state	Dec 42	Clock, \$200 IC digital (Plavcan)*	Apr 23	Warble-tone generator (NC)	Apr 95
Trap, ultra-sharp (NC)	Jan 96	Clocks, IC digital (Lord)*	Sep 43	Weekend sailors (Wutsworth)	May 37
Audio—High fidelity—Stereo		Color bar generator (ER)	Sep 91	Wind-direction indicator (Tech topics)†	Oct 69
Amplifier(s)		Color organ, stereo (Hollins)*	Oct 33	Wired bard technique, use the (Brock)	Mar 23
Bandpass filter, active (Tech topics)†	Oct 63	Color Television—see also Television		Emitter-coupled circuits, experiment with IC (Petrowsky)	Mar 37
Guitar Knight-Kit KG387 (New for you)	Sep 32	Antennas, new (Steckler)	Sep 12	Enlarger timer, automatic*	Dec 50
15-watt IC powerhouse, experiment with (Ashe)*	Sep 33	Buyer's guide to 1969 color sets (Buckwalter)	Jan 42	Etched circuits, how to make (Gupton)	Jun 23
How to fix (In the shop)	Oct 16	Circuits, new (Scott)	Jan 61	Extension cables, testing with (In the shop)	Jun 66
125 watts per channel stereo (Buegel)*	Apr 41	Color-killers, new 1969 (Goodman)	Feb 43	F	
Specs, what's behind (Sutheim)	Jan 70	CRT's		Ferrite rods, repairing (Sutheim)	Aug 47
Stereo—see stereo		changes, 10 steps for fast (In the Shop)	Feb 17	FET(s)	
Bongos, electronic (Jaques)*	Jul 42	Saving (In the Shop)	Mar 16	Square-wave generator (Tooker)*	Aug 48
Booster amplifier, 50-watt (Jaques)*	May 55	Cure gremlins (Mandl)	Apr 35	Tester (ER)	Apr 92
Cassettes '70 (Salm)	Dec 37	Faults		VDR's and thermistors (Sylvania staff)	Apr 55
Crossover(s)		KO quick (Mandl)	Mar 59	15-watt IC powerhouse, experiment with (Ashe)*	Sep 33
Electrical or electronic? (Crowhurst)	Mar 32	Spot fast (Mandl)	Jan 58	50-watt booster amplifier (Jaques)*	May 55
3-way electronic (Crowhurst)*	Oct 42	How color TV works (Mandl)	Jan 35	Filter	
Electronic music		How to fix (Mandl)	Nov 52	Bandpass, active (Tech topics)†	Oct 68
For do-it-yourselfers (Ehle)	Jan 38	Modules, step toward tomorrow with quick-change (Steckler)	Jan 32	Heterodyne, super-sharp (Tech topic)†	Jun 47; Aug 63
Make your own (Ehle)	May 52	Signal tracing (In the shop)	Jan 24	Fire fighters record the action (Magee)	May 71
Fuzz Box (Jaques)	Dec 40	Signal-tracing with "shop" equipment (In the shop)	May 17	Fix those special solid-state TV circuits (Mandl)	Sep 70
FM—see FM stereo		Tint control, automatic (Scott)	Nov 4	Flasher and timer, versatile repeating (NC)	Jun 85
Mixer, four-channel (Jaques)*	Feb 32	Contrast control, high-level (Kwik-Fix™ charts)	Aug 59	FM stereo	
Motiondizer (ER)	Feb 75	Counter decade, transistor	Sep 45	Channel separation nomograph (Applebaum)	Nov 73
On-off switch, remote (NC)	Aug 74	Credit-card snoop	Apr 37	Headset (Lawrence)	Aug 43
Organ		Crossover, 3-way electronic (Crowhurst)*	Oct 42	Receiver	
Color stereo (Hollins)*	Oct 33	Crossovers, electrical or electronic? (Crowhurst)	Mar 32	Solid-state AM/FM (New for you)	Jun 32
Electronic, getting started in servicing (John)	Aug 76	Crossword puzzler (Braun)	Apr 34	Kit (ER)	Jun 68
PA-222 in audio circuits, use the (Ashe)	Feb 54	Changing (In the shop)	Feb 17	Roundup, 1970 (Alderham)	Oct 50
Power IC's for hi-fi (Jones)	Jul 52	Tester, Sencore CR-143 (ER)	Feb 73	Four-channel audio mixer (Jaques)*	Feb 32
Preamp		Cure color TV gremlins (Mandl)	Apr 35	4 safety tips for auto work (Cohn)	Jun 48
Recipe for an IC (Teeling)*	Jul 44	Cutters and pliers (Tools for electronics) (Haskett)	Sep 39; Oct 59	Frequency counter, digital RTL (Botos)*	Aug 23, Sep 52
Stereo (Buegel)*	May 45	D		G	
Speaker(s)		Detector superregenerative (Tech topics)†	Oct 68	Generator	
Bookshelf system (New for you)	Oct 14	Digital	Apr 23	Beginner's dot-bar (Goldberg)*	Jan 50
Design, new approach to (Rosenfeld)	Mar 33	Clock, \$200 IC (Plavcan)*	Sep 23	Color bar (ER)	Sep 91
Enclosures, 16 (Cohen)*	Mar 44	Clocks, IC (Lord)*	Sep 43	FET square-wave (Tooker)	Aug 48
House of the singing driftwood (Fulton)	May 57	IC logic families (Hibberd)	Sep 59	Warble-tone (NC)	Apr 95
Soup up low-quality, how to (Anthony)	Mar 62	Photo enlarger timer (Morton)*	Feb 68	Guitar	
Stereo		Readouts, experiment with (Ashe)	Aug 47	Amplifier (New for you)	Sep 32
Amplifier, Heathkit AA-15 (ER)	Jun 89	RTL frequency counter (Botos)* Aug 23;	Sept 52	Booster amplifier, 50-watt (Jaques)*	May 55
Ampifier, in a phono arm (Francis)*	Mar 52	Dolby system—how it works (Salm)	Oct 35	Vibrato, throbbing (Jaques)†	Apr 45
Ampifier, 125 watts per channel (Buegel)*	Apr 41	Don't let them bug you! (Wels)	Feb 55	H	
Ampifier, 200-watt (Kamp and Sondermeyer)*	Oct 71	Dot-bar generator, beginner's (Goldberg)*	Jan 50	Headphones	
Headphones, hi-fi, R-E staff report on	Oct 39	E		Hi-fi stereo, R-E staff report on	Oct 39
Headphones, Koss ESP-6 (New for you)	Aug 32	Electronic—see also electronics		Stereo (New for you)	Aug 32
Headset, FM (Lawrence)	Aug 43	Bongos (Jaques)*	Jul 42	Headset, FM stereo in this (Lawrence)	Aug 43
Preamp (Buegel)*	May 45	Crossover, 3-way (Crowhurst)*	Oct 42	Heater-cathode shorts (In the shop)	Jul 88
Receiver kit, Scott LR-88 (ER)	Mar 68	Ignition, add to your car (Goldberg and Wilkins)*	Apr 32	Hi-fi (see also Audio—Stereo—High fidelity)	
Receiver roundup, 1970 (Alderham)	Oct 50	Keyer, perfect (Hamlin)*	Nov 69	Stereo headphones, R-E staff report on	Oct 39
Tuner, last-word IC (Buegel)*	Jun 36	Music		High power electronic photoflash (Gupton)*	Feb 23
Tape		For do-it-yourselfers (Ehle)	Jan 38	High-voltage protection for transistors (Hooker)	Oct 58
Dolby system—how it works (Salm)	Oct 52	Organ servicing, getting started in (John)	May 52	Horizontal	
Fire fighters record the action (Magee)	May 71	Photoflash, high-power (Gupton)*	Aug 76	Oscillators, quick-test (Darr)	Oct 69
Treble control with "presence" (Tech topics)†	Aug 42	Throttle for model rr (Mierlak)*	Feb 23	Sweep circuits (Kwik-fix™ charts)	Jun 41
Vibrato, throbbing (Jaques)*	Apr 45	Electronics—see also Automotive electronics;	Nov 42	House of the singing driftwood (Fulton)	May 57
Automatic tint control for color TV (Scott)	Nov 4	Electronic, Industrial electronics		How	
Automation, brains of (Dietrich)	Feb 51	Alarms, intruder—fire, smoke, burglary (Steckler)	Jul 33	Car stereos work (Allen)	Jul 61
Automotive electronics		Alphanumeric fun box with a Nixie (Greenberg)*	Mar 56	Color TV works (Mandl)	Jan 35
Advances in (Holder)	Apr 48	ANOD—audible noise override (Bailey)*	Aug 58	IC logic circuits work (Lancaster)	May 32
Car stereos, how they work (Allen)	Jul 61	Automation, brains of (Dietrich)	Feb 51	J-K flip-flops (Geisler)	Jan 54
Flasher and timer, versatile repeating (NC)	Jun 85	Circuit breadboarding, ABC's of (Ashe)	Nov 62	How to	
4 safety tips for auto work (Cohn)	Jun 48	Clock, \$200 IC digital (Plavcan)*	Apr 23	Fix color (Mandl)	Nov 52
Gages, solid-state your (Saddler)	Aug 38	Clocks, IC digital (Lord)*	Sep 43	Make etched circuits (Gupton)	Jun 23
Ignition, electronic, add to your car (Goldberg and Wilkins)*	Apr 32	Color organ, stereo (Hollins)*	Oct 33	Repair VTR's (Bell)	Jun 79
Light, burned-out, detector (NC)	Jul 95			Soup up low-quality speakers (Anthony)	Mar 68
Tachometer, one-IC (Goldberg)*	Jun 52			Use triggered scopes (Allen)	Aug 32

*Construction articles; † part of larger article, ER (equipment report), NC noteworthy circuits, Carr (correction), CI (service clinic)

TRANSISTOR CURVE TRACER
(continued from page 36)

display, equal to 0.5 V/cm. Thereafter the gain control is left untouched. The vertical attenuator is usually calibrated in multiples and can be changed to suit conditions without affecting the gain control adjustment.

The horizontal input to the scope is turned to EXT and a 10-volt p-p audio signal fed to it. A horizontal line will appear on the scope tube. The horizontal gain is adjusted for a line 5 cm long, equivalent to 2 V/cm. This gain control is also left untouched.

When making various tests it is sometimes necessary to readjust the horizontal gain to other calibration values. Usually 1, 2 and 3 volts p-p/cm will cover most requirements. These points should be found and noted before starting the next steps.

After the scope has been initially calibrated, the tracer sweep dial is marked so that future calibrations can be made utilizing the tracer outputs.

When S3 is at CE, a vertical line is presented on the CRT, and at OFF a horizontal line is displayed (no transistor in socket). The amplitude of these two voltages as well as the ratio between them is determined by the setting of the sweep pot.

With the scope vertical attenuator set at 0.5 V/cm, vertical lines 2, 4 and 6 cm long should be successively displayed by adjusting the sweep pot with S3 at CE. The sweep dial is marked 1, 2 and 3 volts p-p, respectively.

The length of the horizontal lines shown with S3 at OFF is then, with the sweep at 1V p-p, 5.4 cm long with the horizontal gain adjusted for 1 V/cm; with sweep at 2V p-p, 9.6 cm long with horizontal gain at 2V/cm; with sweep at 3V p-p, 9.2 cm long with horizontal gain at 3V/cm. These lines are therefore related to the previous calibration in p-p volts of a sine wave. The horizontal gain can thereafter be calibrated by setting the sweep pot to a calibration mark and obtaining a horizontal line of the correct length.

The values given above will probably vary with different units, but the method should be applicable in all cases.

The maximum current and voltage applied to a transistor must be held within transistor specifications. With the sweep set at 3 volts p-p, the collector current can reach a value of 30 mA at $V_{CE} = 0$, and a collector-emitter voltage of 27 volts at $I_C = 0$. In some cases it may be advantageous to change the value of
(turn page)

ANNOUNCING

An All New MIGHTY MITE Tube Tester

Now Checks more tubes and it's faster than ever before with

- all solid state FET circuitry for instant-on action . . . first time in tube tester history
- New solid action push button function switches to speed up every test:

Here is the latest version of the famous Sencore Mighty Mite tube tester; it's updated and streamlined in appearance and performance. No more wasted time waiting for the tube tester to warm up when you have a hot troublesome tube in your hand ready to test. The TC154 Mighty Mite VI is instant-on with no meter drift. New FET circuitry still enables you to read grid leakage up to 100 megohms because it too is a high impedance device like a vacuum tube. New circuitry permits even higher sensitivity check on heater to cathode leakage; from 180,000 ohms to 300,000 ohms. The Mighty Mite still checks for shorts between each and every tube element with the famous stethoscope shorts check. New two-toned vinyl-covered and brushed steel presents a truly professional instrument. See your Sencore distributor today and ask him for the new all solid state Mighty Mite. Only Sencore has it.

Over 60,000 Mighty Mites now in use.

Only \$89.50



SENCORE

NO. 1 MANUFACTURER OF ELECTRONIC MAINTENANCE EQUIPMENT

426 SOUTH WESTGATE DRIVE, ADDISON, ILLINOIS 60101

Circle 36 on reader service card

Build this exciting Schober Console Organ for only \$1040!*

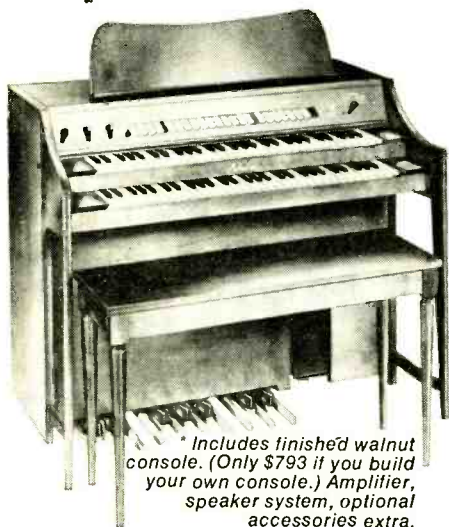

* Includes finished walnut console. (Only \$793 if you build your own console.) Amplifier, speaker system, optional accessories extra.

You couldn't touch an organ like this in a store for less than \$1800—and there never has been an organ of the Console II's graceful small size with 22 such pipelike, versatile voices, five-octave big-organ keyboards, and 17 pedals! It sings and schmaltzes for standards, pops, old-time favorites, speaks with authority for hymns and the lighter classics, all with a range of variety and satisfying authenticity you've never found before in an instrument under church or theatre size. If you've dreamed of an organ of your own, to make your own beautiful music, even if your home or budget is limited, you'll get more joy from a Schober Console II than any other "home size" organ—kit or no kit.

You can learn to play it. And you can build it, from Schober Kits, world famous for ease of assembly without the slightest knowledge of electronics or music, for design and parts quality from the ground up, and—above all—for the highest praise from musicians everywhere.

Send right now for the full-color Schober catalog, containing specifications of all five Schober Organ models, beginning at \$499.50. No charge, no obligation. If you like music, you owe yourself a Schober Organ!

The *Schober* Organ Corp., Dept. RE-73
43 West 61st Street, New York, N.Y. 10023

Please send me Schober Organ Catalog and free 7-inch "sample" record.

Enclosed please find \$1.00 for 12-inch L.P. record of Schober Organ music.

NAME _____

ADDRESS _____

CITY _____ STATE _____ ZIP _____

Circle 37 on reader service card

TRANSISTOR CURVE TRACER (continued from page 77)

the sweep pot. A lower value would decrease the ratio.

In summary, with the tracer outputs connected to the calibrated scope, displaying curves is done by inserting a transistor in the tracer socket, S4 at RUN. Adjust sweep to a calibrated point on the dial and obtain a "set" value for the bias of trace 6. Make notations of the scope vertical and horizontal settings and the base current of trace 6.

The front panel measures 5 x 8¼ inches. A U-bracket 2 5/16 x 8½ inches with ¾-inch lips fits behind this panel.

The chassis measures 4½ x 8 x 5/8 inches and is secured to the lower lip of the bracket by sheet-metal screws. The center of the chassis is cut out to accommodate an epoxy board 3½ x 6¼ inches upon which power supply components are mounted. Two threaded metal spacers 2¼ inches long serve as rear supports for the top board. This board is 4½ x 6¼ inches. The front end is secured to the top lip of the bracket.

The lower transformer is mounted on the left side of the chassis far enough back to allow replacement of the sweep pot if necessary. Sweep

transformer T2 is mounted on a bent metal plate secured to the top lip of the bracket at one end, and to the chassis at the other end. The fuse holder fits on the vertical section of this plate. *Since this is an exposed location be careful and avoid accidental shock.*

The case is a Cowl-type box 5 x 8¾ x 7 inches, reduced in depth to suit the chassis.

Reverse log taper pot R4 gives the maximum resistance in the first 100° or so for minimum base current. This permits higher biases to be set easily.

The miniature trimmers are mounted on a small board raised above the height of the components on the main circuit board and are adjusted from the rear. Also, fixed resistors are used in series with two of the trimmers for ease of adjustment.

Sample curves

A few characteristic curves are shown to illustrate traces produced at different settings of the tracer and scope. The photo of the 2N708 npn transistor curve (Fig. 5) was re-

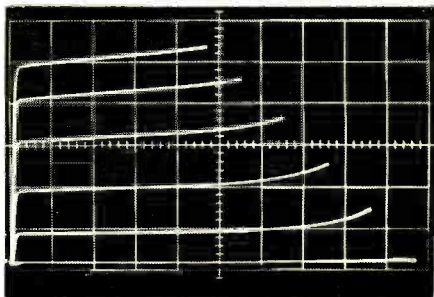

Fig. 5—Scope photo of a 2N708 transistor curve that was "flopped" in the process.

versed in the printing process. The top example of the 2N1038 (Fig. 6)

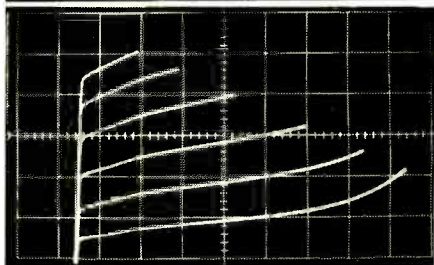
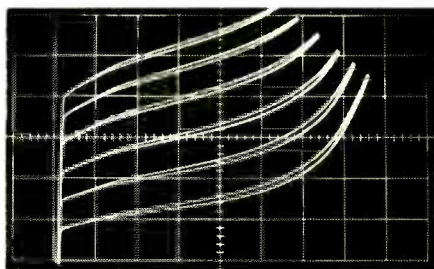

Fig. 6—Photos show temperature distortion (top) and correct curves (lower).

(continued on page 93)

Use
Christmas Seals.
It's a matter of
life and breath.



Christmas Seals
fight emphysema,
tuberculosis,
and air pollution.



Space contributed by the publisher as a public service.

NEW PRODUCTS

More information on new products is available from the manufacturers of items identified by a Reader Service number. Use the Reader Service Card at the left and circle the numbers of the new products on which you would like further information. Detach and mail the postage-paid card.

STEREO CALIBRATION STANDARD, Model 1000ZE stereo cartridge is individually calibrated for flat frequency response within ± 1 dB from 20 to 20,000 Hz. No electrical or mechanical resonant peaks. Total IM distortion at standard 3.54 cm/sec groove velocity does not exceed .05% at any frequency within



the full spectrum. Stereo separation is better than 35 dB at 1 kHz and remains at least 25 dB or better out to 20,000 Hz. Overall frequency response 4 to 40,000 Hz. Output voltage 5 mV per channel. \$99.95. Empire Scientific Corp., 1055 Stewart Ave., Garden City, N. Y. 11530

Circle 46 on reader service card

EMERGENCY REPLACEMENT KITS AC MOTOR CAPACITORS, AK-100, AK-200 can be used to replace almost any

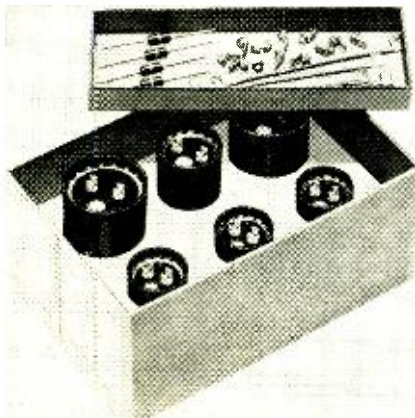

capacitor encountered in day-to-day work. The 4 motor-run capacitors in

the AK100 can be used singly or in combinations to replace almost any capacitor with voltage ratings from 165 through 440 Vac. AK-100 includes assortment of jumper leads with quick-connectors, plus instructions.

AK-200 has 6 motor-start capacitors usable singly or in parallel to obtain 87 capacitance/voltage ratings. Housed in molded plastic cases for complete moisture and mechanical protection, they are equipped with dual-blade universal terminals. Included are four bleeder resistors, six pairs of clip-on terminal adapters, four jumper leads with quick-connectors, and instructions. Packed in strong, compact "Travel-pak" cases for protection of capacitors and accessories en route to and from a job. AK-100, \$32.95. AK-200, \$25.39.—Sprague Products Co., North Adams, Mass. 01247

Circle 47 on reader service card

WELD QUALITY MONITOR, Digimetrics NDT 100, offers nondestructive 100% inspection of resistance welds as each weld is made. Only connections required



are 117-Vac power and simple wire contact to electrode holders of welder. \$975.—Digimetrics Inc., 717 Court St., Utica, N. Y. 13502

Circle 48 on reader service card

AUDIO AMPLIFIER, Model LT-1005, has six individual microphone and/or program inputs which are all transformer-balanced with low impedance. Inputs 1, 2 and 3 are directly coupled from their respective preamplifiers to the tone amplifier. Input 4 has a selector switch for conversion to RIAA phono input. Input 5 is switchable from microphone to an auxiliary 10K unbalanced input. Input 6 features selection of two high-



level lines. Tone controls are full ± 15 dB for bass and treble at 50 Hz and 15 kHz, respectively. Microphone inputs may be changed to 10 dB controlled roll-off at 30 Hz during installation. All inputs and master gain can be remotely controlled through LDR circuits with remote volume controls. Automatic protective circuit protects output stages. Circuit provides instantaneous reduction of output power when short or open occurs in speaker line. Full recovery is achieved in less than 1 msec after the overload or shorted condition is removed.—McMartin Industries, 3104 Farnam St., Omaha, Neb. 68131

Circle 49 on reader service card

COLOR PICTURE TUBE ANALYZER AND REJUVENATOR, Model 880, checks all color tubes in accord with CRT makers' recommended procedures; checks shorts or interelement leakage. Life test for remaining useful cathode-

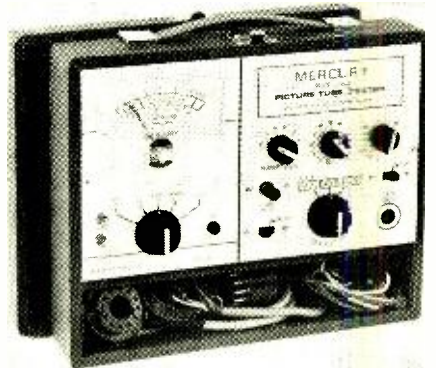

emission life. Each gun of color tube is adjusted to cutoff before beam-current reading is taken. Comes with data book. \$79.95—Mercury Electronics Corp., 315 Roslyn Road, Mincola, N. Y. 11501

Circle 50 on reader service card

PAGING RECEIVER, Model MTA-20. Combines monaural FM receiver, 15-watt, 20-20,000-Hz audio amplifier and microphone input circuit. For paging, background music and hi-fi listening, feeding its own monitor speaker and up to 4 remote speakers simultaneously. Front panel carries tuning, tone and volume controls, hi-fi FM/phone/tape switch, silent spring-return paging switch plus microphone jack. Back panel has microphone paging volume control, switched power outlet, connections for 4 speakers, auxiliary and magnetic phono inputs. Size 14 x 10 x 4" in walnut with

SONAR POWER PACKED PROFESSIONAL FM MONITOR RECEIVERS



AUTO-SCAN

AUTOMATICALLY SCANS 8 PRE-PROGRAMMED CHANNELS—WITH PRIORITY CHANNEL FEATURE

A highly dependable performer with superior professional features. AUTO-SCAN searches and locks automatically on any of 8 pre-programmed channels. Priority Channel locks to the exclusion of other signals • Mobile Callbacks are heard because of carrier delay • Designed for rugged use over wide temperature range • Narrow band operation • Operates from 117VAC and 12VDC, negative or positive ground • Noise free squelch • 8 crystals.

FR-2514 / FR-2515 \$189⁹⁵
(25-50MHz) / (150-175MHz)

Comes with AC and DC power cables, less crystals. Crystals \$5.00 ea.



FR-104/105

PROFESSIONAL

Perfect for Police, Fire, Tow Trucks. Fits the smallest auto yet powerful enough to deliver a clear signal. Solid State, operates on 6 crystal-controlled frequencies, dual conversion, dual limiter. Quadrupled tuned RF stage for greater image rejection. Noise Free Squelch. PLUG IN crystals for instant frequency change. Operates on 117VAC & 12VDC. Negative or Positive ground.

FR-104 / FR-105 \$140⁰⁰
(25-50 MHz) / (150-175 MHz)

Complete with AC and DC power cables, less crystals. Crystals \$5.00 ea.



Crystal Controlled
Base or Mobile

24 CHANNELS

designed for POLICE, FIRE, MUNICIPAL DEPTS. Commercial, Industrial & Other Unlimited Uses
NEW—SONAR EXCLUSIVE! 24 channel professional receivers, engineered to satisfy the most exacting requirements for the professional user. Features unique turret switching design • Exceptional sensitivity and selectivity • Crisp audio sound • Narrow band operation • Noise free squelch • Solid state for reliable operation at high temperatures • Operates from 117VAC and 12VDC • Heavy gauge construction.

FR-2512 / FR-2513 \$169⁹⁵
(25-50 MHz) / (150-175 MHz)

Comes with AC and DC power cables, less crystals. Crystals \$5.00 ea.

SONAR RADIO CORPORATION
73 Wortman Ave., Bklyn, N.Y. 11207

Please send information on Sonar FM Monitor Receivers.

FR2514/15 FR2512/13 FR104/5

Name _____

Address _____

City _____ State _____ Zip _____

Circle 106 on reader service card

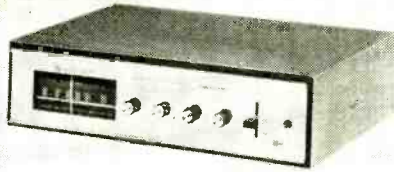

brushed-aluminum panel. \$79.95. Available at Radio Shack stores.—Radio Shack, 730 Commonwealth Ave., Boston, Mass. 02215

Circle 51 on reader service card

FIELD ENGINEER'S TOOL KIT, JTK-17, includes standard tools required for maintenance of complex electronic and data processing equipment.

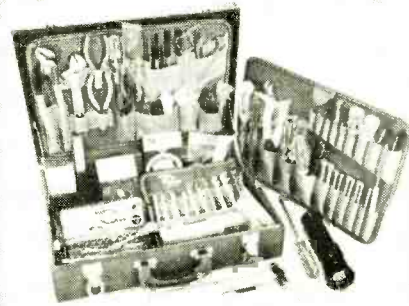

Totaling 100 pieces, kit holds 13 screwdrivers, 7 pairs of pliers, electronic alignment tools, burnishers, crimping tool/bolt cutter, feeler gauge, hammer

Olson

ELECTRONICS

FREE

Catalog

Fill in coupon for a FREE One Year Subscription to OLSON ELECTRONICS Fantastic Value Packed Catalog — Unheard of LOW, LOW PRICES on Brand Name Speakers, Changers, Tubes, Tools, Stereo Amps, Tuners, CB, Hi-Fi's, and thousands of other Electronic Values. Credit plan available.

NAME _____

ADDRESS _____

CITY _____ STATE _____

GIVE ZIP CODE _____

If you have a friend interested in electronics send his name and address for a FREE subscription also.

OLSON ELECTRONICS

529 S. Forge Street, Akron, Ohio 44308

Circle 107 on reader service card

and center punch, flashlight, scribe, electrician's knife, dental mirror, nutdriver set, instrument oiler, pin-punch set, stainless rule, scissors, soldering iron, solder aid, solder brush, tweezers, spring tools, wire stripper, ignition-wrench set, 1/4"-drive-socket set with ratchet handle, metric-type hex-key set. Simpson vom tester is available as optional accessory. \$169.00 (less test meter).—Jensen Tools and Alloys, 4117 N. 44 St., Phoenix, Ariz. 85018

Circle 52 on reader service card

STEREO MINI CHANGER, Model MC22, features automatic or manual play at 4 speeds; automatic shutoff after last record; low-mass tone arm with high-quality ceramic turnover stereo car-



tridge and diamond LP needle; detachable spindle; dynamically balanced 2-pole motor. Premounted on simulated leather base with walnut vinyl trim, heavy-gauge tinted plastic dust cover and all audio cables. Size (including

WORLD'S FINEST

5-CORE SOLDER



ERSIN MULTICORE

ONLY 59¢

BUY IT AT RADIO-TV PARTS STORES
MULTICORE SALES CORP. WESTBURY, N.Y. 11590
Circle 108 on reader service card

RADIO-ELECTRONICS

base) 14% x 5 x 10". \$34.95. For 110-130-V, 60 Hz ac, Stock No. 21-01632 W.—Lafayette Radio Electronics Corp.

Circle 53 on reader service card

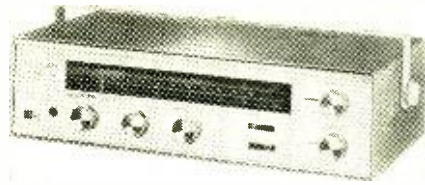

12 1/2 x 9 x 3 1/4". \$99.95. Cat. No. 20-160.—Radio Shack, 730 Commonwealth Ave., Boston, Mass. 02215

Circle 56 on reader service card

BUSINESS INTERCOM. Solid-state design offers background FM/AM radio/tape records in any selected area; choice of four modes of operation to suit changing office requirements. Can be silent. Only call light notifies station being paged. Background music automatically muted. Many optional accessories.—NuTone, Div. of Seovill, Madison and Red Bank Roads, Cincinnati, Ohio 45227

TV SALES AND SERVICE AIDS; How to Double Your Business With Unique Column Ads and Television Repair Promotion. These two manuals pinpoint simple, automatic, effective methods of selling the TV repair shop to gain new customers. Sample ads, typical humor columns and comments on effective use are detailed.—H. K. Simon Co., Inc., Box 236, Dept. REE-1, Hastings-on-Hudson, New York, N.Y. 10706 R-E

Circle 57 on reader service card

NEW LITERATURE

All booklets, catalogs, charts, data sheets and other literature listed here with a Reader's Service number are free for the asking. Turn to the Reader's Service Card facing page 81 and circle the numbers of the items you want. Then detach and mail the card. No postage required!

ELECTRONICS FOR EVERYONE is a 552 page catalog which illustrates and describes with detailed specifications the major brands of high-fidelity components and music systems; record changers and phonographs; tape recorders in all price ranges FM-AM and multibrand radios; TV sets; Citizens band 2-way radios; public address amplifiers; electronics hobby kits; audio radios and tape players; test instruments and meters plus almost everything else you can think of.—Allied Radio Corp., Chicago, Ill.

Circle 76 on reader service card

ELECTRONIC PARTS CATALOG lists precision electronic components with new illustrations and drawings for the established line of components as well as for the new ones. There is a product index that is alphabetically and numerically listed by prefix as well as the table of contents. This 56-page general catalog also provides space for the user to make notes.—Mallory Distributor Prod. Co., Indianapolis, Ind.

Circle 77 on reader service card

SPRING 1969 CATALOG No. 695, 148 pages, illustrates fully with specs and line photos more than 4000 items on science, maths, optics, kits, lamps, tapes and tools etc. for hobbyists, schools and industry. Prices also included.—Edmund Scientific Co., Barrington, N. J. R-E

Circle 78 on reader service card

have you any idea how many ways you can use this handle?

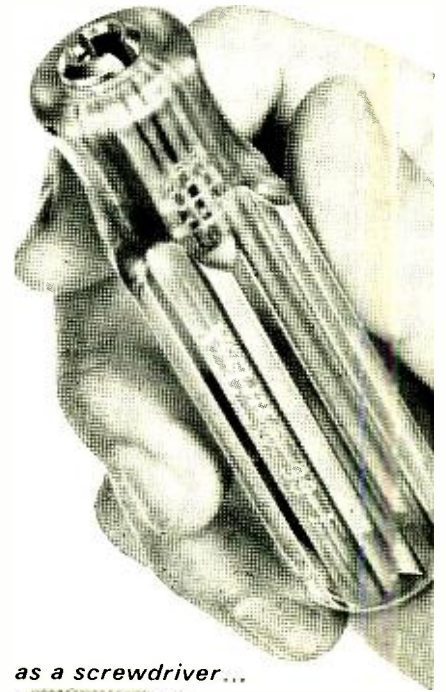

as a screwdriver...



for slotted, Allen hex, Phillips, Frearson, Bristol, Clutch Head, Scrulox® screws

as a nutdriver...



for hex nuts, screws, and bolts

as an awl/scraper and reamer



It accommodates 49 interchangeable blades of various types and sizes.

Its patented spring device permits quick blade insertion and removal.

It's shockproof, breakproof (UL) plastic. Comes in three sizes — regular, junior, stubby — also Tee type.

It's available in a great variety of sets from 39-piece roll kits to compact, pocket cases.

For information on time-saving, space-saving Xcelite "99" tool kits and sets, request Catalog 166.



XCELITE®

XCELITE, INC., 10 Bank St., Orchard Park, N. Y. 14127
In Canada contact Charles W. Pointon, Ltd.

Circle 109 on reader service card

FOCUS SILICON RECTIFIER, CLR 7. Replaces selenium cartridge rectifiers in TV focus-diode applications. It has maximum recurrent peak inverse voltage of 7,000 volts and maximum average forward rectified current of 5 mA at 65°C. Can operate in temperatures up to 70°C with maximum storage temperature of 125°C.—Scientific Components, Inc., 350 Hurst St., Linden, N. J. 07036

Circle 54 on reader service card



WIRELESS MIKE AND HEADSET. The Sharpe RH-27 is wireless with complete if transmitters, receivers and power supply. Electronics are housed in circumaural cup design including active

Circle 55 on reader service card

boom-mounted microphone. Lightweight construction insures freedom of movement. Will not require FCC licensing since it operates at less than 100 milliwatts.—Sharpe Audio Div., Seintrex, Inc., Amherst Industrial Park, Tonawanda, N. Y. 14150



PRO-2 MONITOR RECEIVER, #20-160, high-frequency FM unit with complete tuning system using color-coded scale for 30-50- and 152-174-MHz bands. Delivers 2 watts of audio to built-in speaker or 8-ohm external phones or speaker. Its 28 semiconductor circuit needs less than 0.5 μV input. Squelch control limits noise for band monitoring. Audio signal for tape recording or external audio system available at rear panel. Installation requires steel bracket supplied with unit. Size

Circle 55 on reader service card

DECEMBER 1969

Put The Sound of Christmas In

Announcing The New Heathkit® AR-29 100-Watt
AM-FM-FM Stereo Receiver

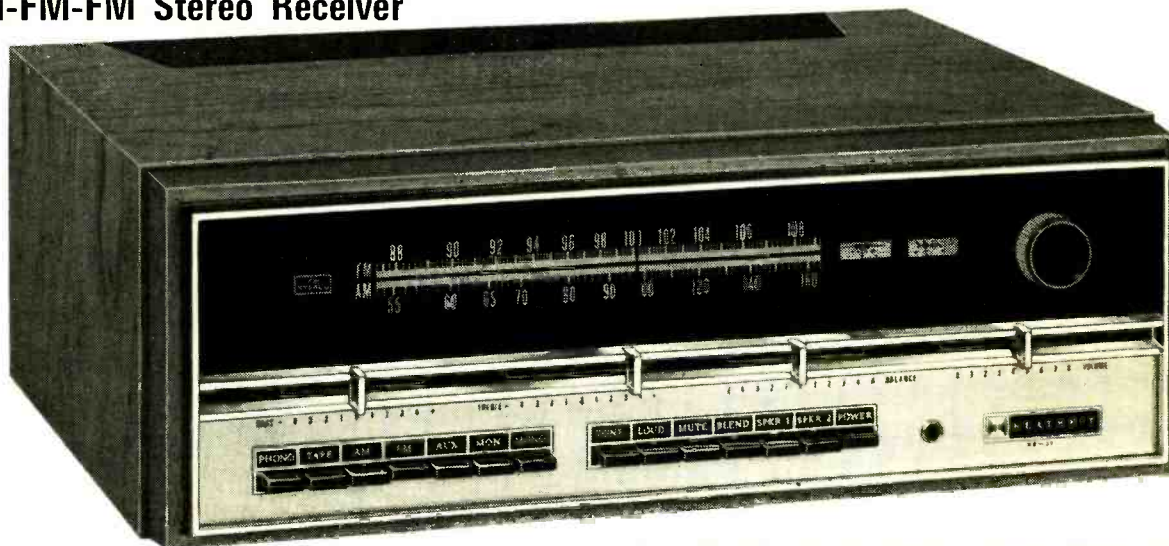

The World's Finest Medium Power Stereo Receiver ...
Designed In The Tradition Of The Famous Heathkit AR-15 ... \$285.00*



Quietly distinctive when not in use ... its impressive midnight black and chrome face unmarred by dial or scale markings. A touch of the power switch and the dial and scale markings appear.

All solid-state design ... 65 transistors, 42 diodes and 4 Integrated Circuits.

Assembled, aligned FET tuning unit.

Advanced 9-pole L-C Filter for greatest selectivity ... a first in the industry.

Plug-In Circuit Boards for easier assembly, easier service ... another first in kits.

Built-In Test Circuitry for voltage and resistance checks without external instruments during construction and after.

Massive Power Supply ... just loaf along at 100 watts output.

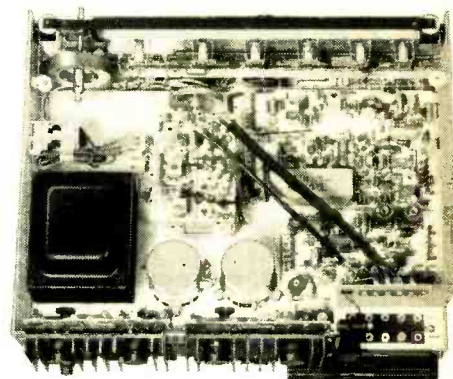

- All solid-state design • 100 watts music power output at 8 ohms • 7-60,000 Hz frequency response • Less than 0.25% Harmonic & 0.2% IM Distortion at full output • Transformerless, direct-coupled outputs with dissipation-limiting circuitry for output protection • Ball-bearing inertia flywheel tuning • Advanced L-C filter gives 70 dB selectivity and elimination of IF alignment • Assembled, aligned FET FM tuner for better than 1.8 uV sensitivity • New Mute Control attenuates between-station FM noise • New Blend Control attenuates noise on FM-Stereo stations • SCA filter • Linear Motion Controls for Bass, Treble, Balance & Volume • Individually adjustable input level controls for each channel of each input keeps volume constant when switching sources • Switches for 2 separate stereo speaker systems • Center speaker capability • Two front-panel meters for precise station tuning • Stereo indicator light • Stereo headphone jack • Swivel AM rod antenna • 300 & 75 ohm FM antenna inputs • Massive, electronically regulated power supply • New Modular Plug-In Circuit Board designed for easy enjoyable assembly

Another Design Leader ... reflecting the heritage of the world-famous Heathkit AR-15. A new milestone in audio history is here: the world's finest medium power stereo receiver ... the Heathkit AR-29.

The Finest Stereo Amplifier In Any Receiver ... delivers a full 100 watts music power, 70 watts continuous — drives even the most inefficient speakers. A giant fully regulated & filtered power supply, 4 individually heat-sinked and protected output transistors and the best specs in the industry add up to unmatched audio fidelity.

The Heath Mark Of Quality: FM Stereo Performance ... now more apparent than ever. The assembled, aligned tuning unit uses FET circuitry for high overload capability, low cross modulation and 1.8 uV sensitivity. Three IC's in the IF give greater AM rejection, hard limiting, excellent temperature stability & reliability. Another IC in the Multiplex section performs four different functions ... assures perfect stereo reproduction.

Kit Exclusive: 9-Pole L-C Filter ... delivers an ideally shaped bandpass with greater than 70 dB selectivity, superior separation and eliminates IF alignment forever.

AM That Sounds Like FM. Three FET's in the AM RF section combine superior sensitivity with greater signal handling capability to give the finest AM reception available. A built-in AM rod antenna swivels for best signal pick-up.

Kit Exclusive: Modular Plug-In Circuit Board Construction ... for simplified assembly ... easier, faster service.

Kit Exclusive: Built-In Test Circuitry lets you not only assemble, test & align your new AR-29, but also *completely* service it — without external test equipment.

You Be The Judge. Compare the specifications ... exciting styling concepts ... the dozens of features ... the price. You'll find that the new Heathkit AR-29 is, indeed, the world's finest medium power stereo receiver. Order yours soon.

Kit AR-29, (less cabinet), 33 lbs. \$285.00*
Assembled AE-19, oiled pecan cabinet, 10 lbs. \$19.95*

PARTIAL AR-29 SPECIFICATIONS — AMPLIFIER: Continuous power output per channel: 35 watts, 8 ohms. **IHF Power output per channel:** 50 watts, 8 ohms. **Frequency response:** —1 dB, 7-60,000 Hz, 1 watt level. **Power Bandwidth for constant 0.25% THD:** Less than 5 Hz to greater than 30 kHz. **Total harmonic distortion:** (Full power output on both channels) Less than 0.25%, 20-20,000 Hz; less than 0.1% @ 1000 Hz. **IM Distortion:** Less than 0.2% (full output, both channels). Less than 0.1% (1 watt output, both channels). **Hum and noise:** (phono input) —65 dB relative to 100 uV signal. **Phono input sensitivity:** 2.2 millivolts (overload 155 millivolts). **FM: Sensitivity:** 1.8 uV or better. **Volume sensitivity:** Below measurable level. **Selectivity:** Greater than 70 dB. **Image rejection:** 90 dB. **IF Rejection:** 90 dB. **Capture ratio:** 1.5 dB. **Total harmonic distortion:** 0.5% or less. **IM Distortion:** 0.4% or less. **Spurious rejection:** Greater than 90 dB. **FM STEREO: Separation:** 40 dB min. @ mid-frequencies; 30 dB @ 50 Hz; 25 dB @ 10 kHz; 20 dB @ 15 kHz. **Frequency response:** ±1 dB, 20-15,000 Hz. **Total harmonic distortion:** 0.5% or less @ 1000 Hz, 100% modulation; 19 kHz & 38 kHz. **Suppression:** 55 dB. **SCA Suppression:** 55 dB. **AM SECTION: Sensitivity:** (using built-in rod antenna): 200 uV/M @ 600 kHz; 300 uV/M @ 1400 kHz (IHF rated). **Selectivity:** Greater than 40 dB alternate channel. **Image rejection:** 60 dB @ 600 kHz; 45 dB @ 1400 kHz. **IF Rejection:** Greater than 50 dB. **Harmonic distortion:** Less than 2%. **Hum & Noise:** —35 dB.

Your Home With Heathkit® Stereo



Kit AR-15
\$349.95*
(less cabinet)

Wired
ARW-15
\$540.00*
(less cabinet)



Kit AD-27
\$179.95*



Kit AR-14
\$119.95*
(less cabinet)

Assembled
ARW-14
\$169.95*

(with AE-55 cabinet)

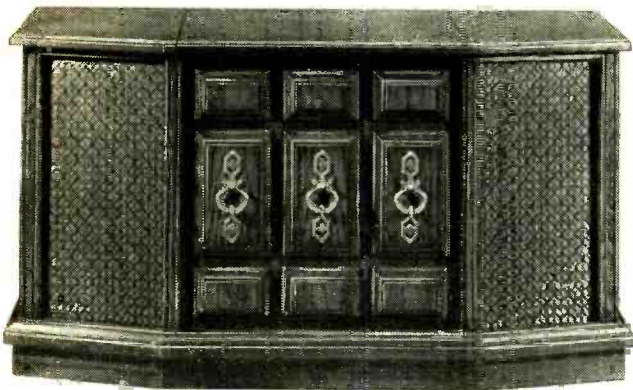

Lifting the spring loaded hinged top reveals the heart of the new AD-19... the famous Heathkit AR-14 Stereo Receiver circuitry, combined with the precision-crafted BSR McDonald 500A Automatic Turntable. Note the clean control layout... everything easily in reach from a standing position. A handy compartment in front keeps your records clean and convenient.

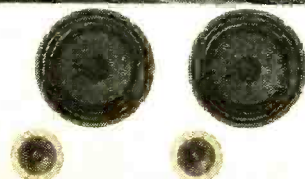

Component-Quality Speaker Systems. The new AD-19 cabinet houses two completely independent, ported speaker systems for reproduction comparable to that of systems of individual components. The 10" woofer and 3 1/2" tweeter combine to give clean, lifelike response from 60 Hz to 16,000 Hz.

HEATHKIT AR-15 Deluxe Solid-State Receiver

The Heathkit AR-15 has been highly praised by every leading audio and electronics magazine, every major testing organization and thousands of owners as THE stereo receiver. Here's why. The powerful solid-state circuit delivers 150 watts of music power, 75 watts per channel, at ± 1 dB, 8 Hz to 40 kHz response. Harmonic & IM distortion are both less than 0.5% at full rated output. The world's most sensitive FM tuner includes these advanced design features... Cascade 2-stage FET RF amplifier and an FET mixer for high overload capability, excellent cross modulation and image rejection... Sensitivity of 1.8 uV or better... Harmonic & IM distortion both less than 0.5%... Crystal Filters in the IF section give a selectivity of 70 dB under the most adverse conditions. Adjustable Phase Control for maximum separation... elaborate noise operated squelch... stereo only switch... stereo indicator light... two front panel stereo headphone jacks... front panel input level controls, and much more. Easy circuit board construction. For the finest stereo receiver you can buy anywhere, order your AR-15 now. 34 lbs. Optional walnut cabinet, AE-16. 10 lbs... \$24.95*

HEATHKIT AD-27 FM Stereo Compact

Heath engineers took the highly-rated AR-14 solid-state Stereo Receiver circuitry, matched it with the precision BSR McDonald 500A Automatic Turntable and put this quality component combination in a sliding tambour door walnut cabinet. Performance? The AD-27 delivers 30 watts music power... full 15 watts per channel — enough to drive any reasonably efficient speaker system. Response is virtually flat from 12-60,000 Hz, and Harmonic & IM Distortion are both less than 1% at full output. Tandem Volume, Bass, Treble & Balance Controls give you full range command of the sound. Flick the rocker-type switch to select the FM stereo mode, and tune smoothly across the dial with the inertia flywheel tuning. You'll hear stations you didn't know existed, with a clarity and separation that will amaze you. An adjustable phasing control assures best separation always, and the automatic stereo indicator light comes on when the station is broadcasting in stereo. AFC eliminates drift too. The BSR McDonald 500A includes cueing/pause control, variable anti-skating adjustment, stylus pressure control, automatic system power and many other features usually found only on very expensive units. Includes a famous Shure diamond stylus stereo cartridge too. Add this handsomely-styled, top performing stereo compact to your home now. 41 lbs.

HEATHKIT AR-14 FM Stereo Receiver

The AR-14 has been rated as the best value obtainable in a medium power stereo receiver... and it's easy to see why. The all solid-state circuit delivers 30 watts music power from 15-50,000 Hz... total distortion is less than 1% at full output. The AR-14 may be small, but its FM tuner section boasts high sensitivity, excellent selectivity and very low noise to give you FM stereo performance you will marvel at. Complete inputs and outputs, of course, for greatest system flexibility. Other features include stereo headphone jack, stereo indicator light and filtered outputs for beat-free taping. Make this amazing little receiver the heart of your new stereo system now. 18 lbs.

New Heathkit "Component Credenza" Combines Quality Stereo Components With Beautiful Mediterranean Styling... \$299.95*

- Combines all solid-state FM stereo receiver, 4-speed automatic turntable with diamond stylus and two full-range, two-way speaker systems into a luxurious Mediterranean cabinet
- 15 watts per channel music power output
- Full range tone controls
- Very low Harmonic & IM Distortion
- Excellent channel separation
- Transformerless output circuit for minimum phase shift, wide response
- Electronically filtered power supply
- Stereo headphone jack
- Auxiliary input
- Filtered tape output
- Excellent FM tuner selectivity & sensitivity
- 4-stage IF
- AFC
- Stereo indicator light
- SCA filter
- High quality BSR McDonald 500A Automatic Turntable with low mass counterbalanced aluminum tone arm plays up to 6 records
- Comes with Shure diamond stylus magnetic cartridge
- Vernier stylus pressure adjustment
- Anti-Skate control
- Cue/Pause control
- Two ducted-port reflex 2-way speaker systems for performance comparable to fine component-type separate speaker systems
- Each system contains 10" high compliance woofer & 3 1/2" ring-damped tweeter for 60-16,000 Hz response
- Complete system housed in a magnificent factory assembled Mediterranean cabinet of beautiful oak veneers with solid oak trim
- Easy assembly with the famous Heathkit Manual... build only the receiver & install the components
- The finest value anywhere in quality stereo consoles

Real Stereo Performance Demands Real Stereo Components... the kind used for custom-designed systems. The new "Component Credenza" as the name implies, integrates separate components into a single functional unit. Here are those components...

Component-Quality FM Stereo Receiver. The heart of the new AD-19 is the famous Heathkit AR-14 FM-FM-Stereo Receiver circuitry. The amplifier produces a solid 30 watts IHF music power. The FM Stereo tuner features 5 uV sensitivity, excellent separation and flywheel tuning. The AR-14 has been rated as the best value obtainable in a medium power receiver.

Component-Quality 4-Speed Automatic Turntable with such professional features as Cue/Pause control, Anti-Skate control, adjustable stylus pressure and famous Shure diamond stylus magnetic cartridge.

Component-Quality Speaker Systems. Two independent, ported speaker systems, each with a 10" woofer and 3 1/2" tweeter deliver 60-16,000 Hz response for remarkable fidelity.

Elegant Mediterranean Oak Cabinet... a fine example of cabinet-making, flawlessly executed in oak veneer with solid oak trim. Rigidly constructed using fine-furniture techniques.

The New Heathkit AD-19 "Component Credenza"... A Masterpiece in sight and sound. Put it in your home now.

Kit AD-19, 158 lbs. \$299.95*

Make This Christmas a

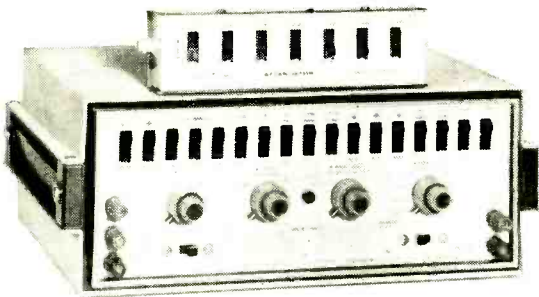

NEW Kit IG-57A

\$135⁰⁰*



NEW Kit IG-28

\$79⁹⁵*

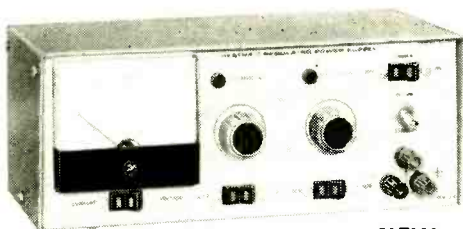

NEW Kit IP-28

\$47⁵⁰*



NEW Kit GR-78

\$129⁹⁵*



NEW Kit GD-209A

\$149⁹⁵*

NEW, Improved Heathkit IG-57A Solid-State Post Marker/Sweep Generator . . . Now With Built-In Video Sweep Modulator

Now align virtually every color and B&W TV set on the market with the new Heathkit IG-57A. New built-in Video Sweep Modulation eliminates the need for external equipment—the IG-57A and a scope are all you need to check the overall frequency response from the antenna terminals thru the tuner, IF strip, video detector to the color bandpass amplifier outputs. And you don't have to worry about video detector diode load. Another new feature is the addition of two individually adjustable 15 volt bias supplies with switchable polarity. Additional features: 15 crystal-controlled markers for color bandpass, TV sound, IF frequencies between 39.75 & 47.25 MHz and picture & sound carriers for channels 4 & 10 . . . switchable retrace blanking . . . adjustable phase control . . . trace reverse function for proper display . . . built-in switchable 400 Hz modulator . . . Zener regulated power supply . . . external attenuator for 1, 3, 6, 10 & 20 dB steps up to 70 dB . . . complete with all test leads, cables, connectors & plugs. Put complete servicing facilities on your bench now, with the new Heathkit IG-57A. 14 lbs.

NEW Heathkit Color Bar-Dot Generator . . . Advanced Integrated Circuitry Produces 12 Patterns Plus Clear Raster, Eliminates Divider Chain Instability Forever

The new IG-28 is the signal source for all color and B&W TV servicing. No other instrument at any price will give as much stable, versatile TV servicing capability. Its solid-state circuitry produces dots, cross hatch, vertical and horizontal bars, color bars, and shading bars in the familiar 9x9 display . . . plus exclusive Heath 3x3 display of all these patterns . . . plus a clear raster that lets you adjust purity without upsetting AGC adjustment. Fifteen J-K Flip-Flops and associated gates count down from a crystal controlled oscillator, eliminating divider chain instability and adjustments. And for time-saving convenience the IG-28 has variable front panel tuning for channels 2 through 6. Plus & minus going video signals at the turn of a front panel control . . . for sync, in-circuit video or chroma problems, use the front panel sync output. Two front panel AC outlets for test gear, TV set, etc. Built-in gun shorting circuits and grid jacks too. Add any service-type scope with horizontal input and you have vectorscope display capability as well. Fast, enjoyable circuit board-wiring harness construction. You can't beat the Heathkit IG-28 for versatility or value . . . put it on your bench now. 8 lbs.

NEW Heathkit 1-30 VDC Solid-State Regulated Power Supply

The new modestly priced IP-28 is an excellent power supply for anyone working with transistors. Compact Heathkit instrument styling with large, easy-to-read meter . . . two voltage ranges — 10 V., 30 V. . . two current ranges — 100 mA, 1 A. External sensing permits regulation of load voltage rather than terminal voltage. Adjustable current limiting prevents supply overloads and excessive load current. Convenient standby switch. Fast, easy assembly with one circuit board and wiring harness. Order yours today! 9 lbs.

NEW Heathkit GR-78 Solid-State General Coverage Receiver . . . Tunes 190 kHz To 30 MHz In Six Bands

The new GR-78 combines wide coverage, superior performance and portability with sharp styling to provide a remarkable value in general coverage receivers. Tunes AM, CW & SSB signals from 190 kHz to 30 MHz in six switch-selected bands. The all solid-state circuit employs modern FET's in the RF section and 4 ceramic filters in the IF to deliver maximum sensitivity and sharp selectivity. Bandsread Tuning is built-in, and can be calibrated for either Shortwave Broadcast or Amateur Bands. Completely portable . . . comes with a nickel-cadmium rechargeable battery pack and built-in charger that operates from 120 or 240 VAC and 12 VDC. Many built-in features . . . 500 kHz crystal calibrator . . . switchable Automatic Noise Limiter . . . switchable Automatic Volume Control . . . Receiver Muting . . . Headphone Jack and many more. Order yours today. 14 lbs.

NEW Heathkit Deluxe Radio-Controlled Screw-Drive Garage Door Opener Semi-Kit

The next best thing to a personal doorman. The "wireless" factory assembled transmitter operates up to 150 feet away. Just push the button and your garage door opens and the light turns on . . . and stays on until you're safely inside your home. The giant 7 ft. screw mechanism coupled with the 1/4 HP motor mean real power and reliability and the adjustable spring-tension clutch automatically reverses the door when it meets any obstruction . . . extra safety for kids, pets, bikes, even car tops. Assembles completely without soldering in just one evening. Easy, fast installation on any 7' overhead track (and jamb & pivot doors with accessory adapter). Order yours now. 66 lbs.

Adapter arm for jamb & pivot doors, Model GDA-209-2. \$7.95*

Heathkit® Holiday



Heathkit "681" Color TV...AFT... New Brighter Picture Tube For More Vivid Colors, Better Resolution

The new Heathkit GR-681 is the world's most advanced Color TV with more built-in features than any other set on the market. Automatic Fine Tuning on all 83 channels... power push button VHF channel selection, built-in cable-type remote control... or you can add the optional GRA-681-6 Wireless Remote Control any time... plus the built-in self-servicing aids that are standard on all Heathkit color TV's. Other features include high & low AC taps to insure that the picture transmitted exactly fits the "681" screen, automatic degaussing, 2-speed transistor UHF tuner, hi-fi sound output, two VHF antenna inputs, top quality American brand color tube with 2-year warranty. With optional new RCA Matrix picture tube that doubles the brightness, Model GR-681MX only \$535.00.

GRA-295-4, Mediterranean Cabinet shown... **\$124.95***

Heathkit "295" Color TV... New Picture Tube For Brighter, Sharper Pictures

With Optional RCA Matrix Tube... with the same high performance features and built-in servicing facilities as GR-681 above... less AFT, VHF power tuning and built-in cable-type remote control. You can add the optional GRA-295-6 Wireless Remote Control at any time. New optional RCA Matrix tube doubles the brightness, Model GR-295MX, \$485.00.

GRA-295-1, Contemporary Walnut Cabinet shown... **\$64.95***

Both the GR-681 and GR-295 fit into the same Heath factory assembled cabinets; not shown Early American style at \$109.95*

Heathkit "581" Color TV... Sharper, Brighter Viewing With New Picture Tube... AFT

The new Heathkit GR-581 will add a new dimension to your TV viewing. Brings you color pictures so beautiful, so natural, so real... puts professional motion picture quality right into your living room. Has the same high performance features and exclusive self-servicing facilities as the GR-681, except with 227 sq. inch viewing area, and without power VHF tuning or built-in cable-type remote control. The optional GRA-227-6 Wireless Remote Control can be added any time you wish. And like all Heathkit Color TV's you have a choice of different installations... mount it in a wall, your own custom cabinet, your favorite B&W TV cabinet, or any one of the Heath factory assembled cabinets.

GRA-227-2, Mediterranean Oak Cabinet shown... **\$109.95***

Heathkit "227" With New Picture Tube For Increased Brightness & Better Resolution

Same as the GR-581 above, but without Automatic Fine Tuning... same superlative performance, same remarkable color picture quality, same built-in servicing aids. Like all Heathkit Color TV's you can add optional Wireless Remote Control at any time (GRA-227-6). And the new Table Model TV Cabinet and roll around Cart is an economical way to house your "227"... just roll it anywhere, its rich appearance will enhance any room decor.

GRS-227-5, New Cart and Cabinet combo shown... **\$54.95***

Both the GR-581 and GR-227 fit into the same Heath factory assembled cabinets; not shown, Contemporary cabinet \$64.95*

Heathkit "481" Color TV with AFT

The new Heathkit GR-481 has all the same high performance features and exclusive self-servicing aids as the new GR-581, but with a smaller tube size... 180 sq. inches. And like all Heathkit Color TV's it's easy to assemble... no experience needed. The famous Heathkit Color TV Manual guides you every step of the way with simple to understand instructions, giant fold-out pictorials... even lets you do your own servicing for savings of over \$200 throughout the life of your set. If you want a deluxe color TV at a budget price the new Heathkit GR-481 is for you.

GRA-180-1, Contemporary Walnut Cabinet shown... **\$49.95***

Heathkit "180" Color TV

Feature for feature the Heathkit "180" is your best buy in color TV viewing... has all the superlative performance characteristics of the GR-481, but less Automatic Fine Tuning. For extra savings, extra beauty and convenience, add the table model cabinet and mobile cart. Get the value-packed GR-180 today.

GRS-180-5, Table Model Cabinet & Cart combo... **\$42.50***

Both the GR-481 and GR-180 fit the same Heath factory assembled cabinets: GRA-180-2, Early American Cabinet \$94.95*

Add the Comfort And Convenience Of Full Color Wireless Remote Control To Any Rectangular Tube Heathkit Color TV... New Or Old!

Kit GRA-681-6, for Heathkit GR-681 Color TV's... **\$64.95***

Kit GRA-295-6, for Heathkit GR-295 & GR-25 TV's... **\$69.95***

Kit GRA-227-6, for Heathkit GR-581; GR-481 & GR-180 Color TV's... **\$69.95***

Now There Are 6 Heathkit® Color TV's To Choose From

2 Models In 295 Sq. Inch Size

NEW

Kit GR-681
With AFT

\$499.95*

(less cabinet)



Kit GR-295

\$449.95*

(less cabinet)

2 Models In 227 Sq. Inch Size

NEW

Kit GR-581
with AFT

\$419.95*

(less cabinet)



Kit GR-227

NOW ONLY

\$379.95*

(less cabinet
& cart)

2 Models In 180 Sq. Inch Size

NEW

Kit GR-481
with AFT

\$359.95*

(less cabinet)



Kit GR-180

NOW ONLY

\$329.95*

(less cabinet & cart)

Reception Is Simulated
On All Sets Shown



a Schlumberger subsidiary



NEW

FREE 1970 CATALOG!

Now with more kits, more color. Fully describes these along with over 300 kits for stereo/hi-fi, color TV, electronic organs, electric guitar & amplifier, amateur radio, marine, educational, CB, home & hobby. Mail coupon or write Heath Company, Benton Harbor, Michigan 49022.

HEATH COMPANY, Dept. 20-69
Benton Harbor, Michigan 49022

Enclosed is \$ _____, plus shipping.

Please send model (s) _____

Please send FREE Heathkit Catalog.

Please send Credit Application.

Name _____

Address _____

City _____

State _____

Zip _____

*Mail order prices; F.O.B. factory. Prices & specifications subject to change without notice.

CL-370

Circle 110 on reader service card

UNEXCELLED! THE UVM ANTENNA

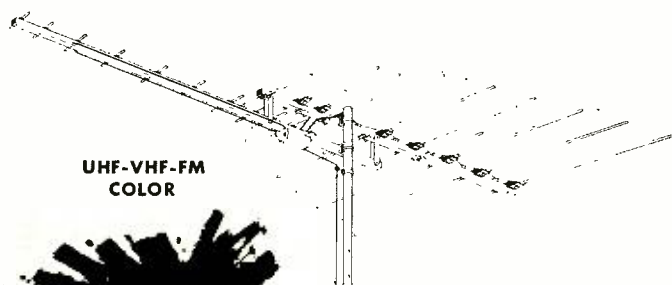

UHF-VHF-FM
COLOR

**COMPLETELY
NEW!**

Combination
UHF-VHF-FM Antennas
for superior performance.

Tuned and engineered featuring a LOG PERIODIC VHF section incorporating a PATENTED MAGNETIC WAVE design for UHF. Discriminate between desired signal and unwanted noise. An absence of minor lobes and extremely high front to back ratio are characteristics of these antennas. Mechanical features include all new fittings and special alloy aluminum tubing for added strength. Six models available.

Write or phone for complete information.

S & A ELECTRONICS, INC.

210 W. Florence St. Phone (419) 693-0528 Toledo, Ohio 43605

Circle 111 on reader service card

TECHNOTES

DEFECTIVE DEGAUSSING CIRCUIT

If you run across a color set where the degaussing circuit magnetizes the picture tube instead of demagnetizing

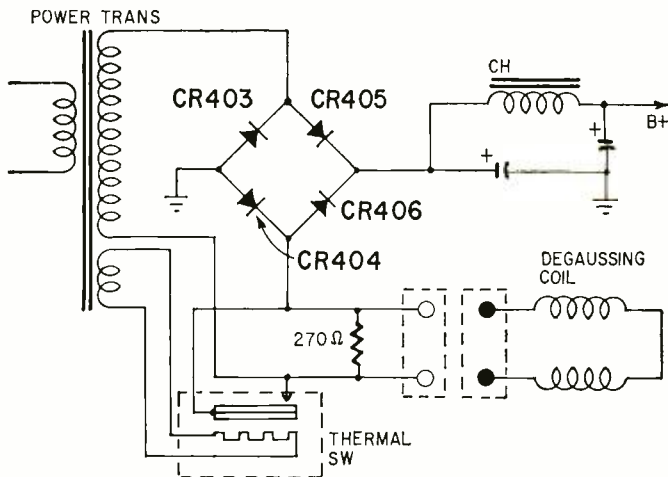

it, check the bridge rectifier (CR-403, CR404, CR405) or CR406 in the diagram) for an open rectifier element or a poor solder joint.—Admiral Service News Letter

TV TRAP ALIGNMENT

A new TV trap alignment procedure consists of using the alignment generator set at the trap frequency in the usual way and then adding a small amount of audio modulation, usually available from the generator. In theory, we are using the trap frequency as a carrier while the modula-

BIG SAVINGS—ALL NEW BARGAINS

FREE \$1 BUY WITH EVERY 10 YOU ORDER Only applies to "\$1" Buys FREE GIFT WITH EVERY ORDER

MARKET SCOOP COLUMN

- 12" OXFORD SPEAKER. Top Quality . . . Large Magnet . . . \$4
- 10" PHILCO SPEAKER. Top Quality . . . Large Magnet \$2.69
- 6" ECONOMY SPEAKER. Top Quality 2-15 Mag. . . \$1.69
- 5" UNIVERSAL TWEETER \$1.29
- 1 Oz. . . Magnet
- UNIVERSAL 5 1/2" PM SPEAKER \$1
- Alnico 5 magnet, quality tone . . .
- UNIVERSAL 4" PM SPEAKER 79c
- Alnico 5 magnet, quality tone . . .
- 2" x 6" SPEAKER \$1
- Alnico 5 magnet, quality tone . . .
- 2 1/2" x 4" SPEAKER 69c
- Special Buy . . .
- 3 1/2" — ROUND SPEAKER 59c
- Special Buy . . .
- 25 — 3900-OHM-7w RESISTOR \$1
- 10% Corning glass . . .
- 20 — .47-600V CONDENSERS \$1
- White Ceramic C.D.—American . . .
- SPECIAL TUBE BUY 3CG6, 3DT6, 4CS6, 12AU7, 12BH7. Each . . . 49c
- 10 — ASST. RADIO & TV TUBES \$1
- Every Tube a good number . . .
- 3-PRINTED CIRCUIT IF TRANSFORMERS 4-Lug, 456 KC . . . \$1
- 70—BRASS FAHNESTOCK CLIPS \$1
- popular type & size . . .
- 20 — ASST. PILOT LIGHTS \$1
- #44, 46, 47, 51, etc. . . .
- 50 — ASSORTED #3AG FUSES \$1
- popular ampere ratings . . .

- 300 — ASST. 1/2 W RESISTORS Top Brand, Short Leads, Excellent Selection . . . \$1
- 100—ASST 1/4 WATT RESISTORS stand. choice ohmages, some in 5% \$1
- 100—ASST 1/2 WATT RESISTORS stand. choice ohmages, some in 5% \$1
- 70 — ASST 1 WATT RESISTORS stand. choice ohmages, some in 5% \$1
- 35 — ASST 2 WATT RESISTORS stand. choice ohmages, some in 5% \$1
- 50 — PRECISION RESISTORS asst. list-price \$50 less 98% . . . \$1
- 20 — ASSORTED WIREWOUND RESISTORS, 5, 10, 20 watt . . . \$1
- 4 — TOGGLE SWITCHES SPST, SPDT, DPST, DPDT . . . \$1
- 10—ASSORTED SLIDE SWITCHES SPST, SPDT, DPDT, etc. . . . \$1
- TV TUNER — asst. all new standard makes, Less tubes . . . \$1
- TV TUNERS asst. all new standard makes, including Tubes . . . \$3
- WESTINGHOUSE STANDARD TUNER #470V120H01 — #3GK5 — 6CG8 Tubes . . . \$4
- UHF TUNER — TRANSISTOR TYPE Used in all TV Sets . . . \$3.95
- 50 — 3#AG FUSES 10 AMP. popular type with pigtails . . . \$1
- 10 — SURE-GRIP ALLIGATOR CLIPS 2" plated . . . \$1
- 50 — ASSORTED PRINTED CIRCUIT SOCKETS best types . . . \$1
- 10 SETS — DELUXE PLUGS & JACKS asst. for many purposes . . . \$1

- 4 — 50' HANKS HOOK-UP WIRE assorted colors . . . \$1
- 100' — SPOOL SPEAKER WIRE 2 cond. mini zip, clear, 101 uses \$1
- 100' — TV TWIN LEAD-IN WIRE 300 ohm, deluxe heavy duty, clear \$2
- UNIVERSAL TV ANTENNA Back of set mounting . . . \$1.98
- 5 section rods . . .
- 3 Way UHF—VHF—FMSPLITTER Two Sets of terminals make hook-up a cinch . . . \$1.98
- 5 — 6' LINE CORDS #18 Stranded Copper Wire . . . \$1
- MOTOROLA PWR TRANSFORM 110v, CT 150/150v, 6.3v . . . \$1
- 10 — TRANSFORMERS assorted Audio Outputs, Chokes, I, F, 's, etc. \$1
- 8 — ASST. LUCITE CABINETS hinge cover, handy for parts . . . \$1
- 20—PENLITE BATTERIES 1 1/2v . . . \$1
- 15—BATTERIES C-cell similar 935 . . . \$1
- 10—BATTERIES D-cell similar 950 . . . \$1
- 5—BATTERIES (Transistor) similar 216 \$1
- 100' — FINEST NYLON DIAL CORD best size, .028 gauge . . . \$1
- COLOR-TV RECTIFIER — Used in most color sets—6500 PIV (Volts) . . . 3 for \$1.95
- STANDARD TV TUNER 21mc— with schematic Popular type for many TV's . . . \$5
- 12—MINIATURE ELECTROLYTIC CONDENSERS For Transistor & miniature work . . . \$1
- 10 — MINIATURE 456KC IF TRANSFORMERS Exceptional value —PC—1/2" x 1/2" . . . \$1
- HEAVY DUTY COLOR FOCUS RECTIFIER 14,000 PIV @ 1 ma . . . \$1

- TRANSISTOR RADIO asst type good, bad, broken, as-is, potluck \$1.50
- TAPE RECORDER — assorted types good, bad, broken, as-is, potluck . . . \$4
- 32' — TEST PROD WIRE deluxe quality, red or black . . . \$1
- HEARING AID AMPLIFIER Incl. 3 Tubes, Mike, etc. (as is) . . . \$1
- COLOR POWER TRANSFORMER — Good for most sets 26R150 List Price—\$36.75 \$6.95
- 6 — TRANSISTOR RADIO EAR-PIECES wired complete with plug most popular brown & gold design \$1
- 1—SQ. YARD GRILLE CLOTH \$1
- \$20—SHURE M-7D DIAMOND NEEDLE exact replacement . . . \$2
- \$15.00 TELEVISION PARTS \$3
- "JACKPOT" best buy ever . . . \$3
- 10 — SETS PHONO PLUGS & PIN JACKS RCA type . . . \$1
- 20—ELECTROLYTIC CONDENSERS Fine asst.-too numerous to mention \$1
- 20 — ASST. VOLUME CONTROLS All desirable good types . . . \$1
- 2 — POWER TRANSISTORS Be- place 2N155, 2N176, 2N301, etc. \$1
- 2 — HYTRON POWER TRANSISTOR H.V. replaces DS501, 2N173, etc. . . . \$1.29
- 50 — OIL IMPREGNATED TUBULAR CAPACITORS Porcelain, Axial Leads—Most popular values . . . \$3.25
- 2 — COLORBURST QUARTZ-CRYSTAL REPLACEMENT For most Color TV Sets . . . 3579.545 \$1.49
- 25 — #130 WESTINGHOUSE PILOT BULBS 5000 Hours. . . Same as #47 . . . \$1
- 50 — .0033 DISC CERAMIC CAPACITORS C.R.L.C. . . . \$1

IMMEDIATE DELIVERY . . . Scientific light packing for safe delivery at minimum cost. HANDY WAY TO ORDER: Pencil mark or write amounts wanted in each box, place letter F in box for Free \$1 BUY. Enclose with check or money order, add extra for shipping. Tearsheets will be returned as packing slips in your order, plus lists of new offers.

Minimum Order \$3.00

Please specify refund on shipping overpayment desired: CHECK POSTAGE STAMPS MERCHANDISE (our choice) with advantage to customer

Name
Address
Cost of goods
Shipping estimated
TOTAL

BROOKS RADIO & TV CORP., 487 Columbus Ave., New York, N. Y. 10024 212-874 5600 TELEPHONE

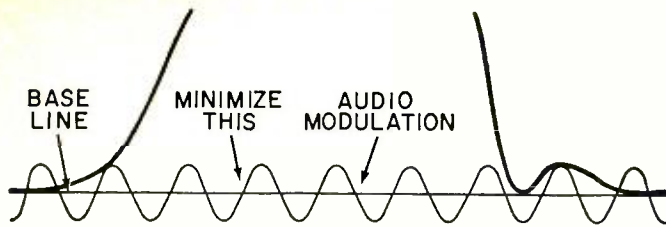

DO NOT CONFUSE AUDIO MODULATION WITH CALIBRATING BEAT, WHILE NULLING TRAPS

tion forms sidebands which appear on the base line as sine waves (see drawing).

To adjust the trap, observe the trace on the scope and vary the trap adjustments to minimize or null the audio on the base line. This method gives a much more useable indication—you really know when the trap is set correctly. Be sure to keep the audio modulation at a low level as shown in the drawing.—Admiral Service News Letter

OLYMPIC CTC 19/21/31

Some of these late-production chassis may have complaints of intermittent color. This problem is occasionally brought on by vibrating or flexing the chroma board. Inspecting the socket of tube V703 (the 6GH8 color oscillator and control tube) may show that resistor R746 (1500 ohms going to pin 9) may be shorting against capacitor C724 (82 pF at pin 3) due to a shift in the position of spaghetti insulation. Relocate the resistor to provide sufficient clearance.—Olympic Service Bulletin **R-E**

COMING NEXT MONTH

If you know your way around late-model color TV circuits, don't miss January's issue for an add-on automatic tint control.

It's yours
free

for the asking!



**GIANT 274 PAGE
1970
RADIO-TV
ELECTRONICS
CATALOG**

YOUR BUYING GUIDE FOR...
TV's, Radios, Recorders, Phonos, Amateur and CB equipment, electronic parts, tubes and test equipment... featuring B-A's famous big bargain packed section!

Write to:
BURSTEIN-APPLEBEE CO.,
DEPT. RE-L 3199 MERCIER ST.,
KANSAS CITY, MO. 64111

Name _____
Address _____
City _____
State _____ Zip Code _____



Circle 112 on reader service card

SHANNON MYLAR RECORDING TAPE

2 1/2" - 225' .. \$.17	7" - 2400' \$1.79
3" - 225' .. .19	7" - 3600' 2.95
3" - 300' .. .27	CASSETTE 60 minutes .89
3 1/4" - 600' .. .58	CASSETTE 90 minutes 1.54
5" - 600' .. .62	CASSETTE 120 minutes 1.97
5" - 900' .. .80	
5" - 1200' .. .97	2 1/2" TAPE REEL04
5" - 1800' .. 1.49	3" TAPE REEL05
7" - 1200' .. .77	3 1/4" TAPE REEL06
7" - 1800' .. 1.12	5" TAPE REEL12
	7" TAPE REEL14

CANADIANS: Ordering is easy — we do the paperwork — try a small order

**ALL TRANSISTOR HOME
OFFICE MESSAGE CENTER**

Famous Manufacturer

Leaves messages for other for replay... Built in speaker/microphone for talk-into convenience... Records up to 3 minutes of messages... Illuminated signal shows when a message is waiting. Control adjusts playback volume without affecting recording volume... Capstan Drive; BRAND NEW \$10 SOLD AS IS

IBM COMPUTER SECTIONS

8 assorted Units we sell for \$1 are loaded with over 150 valuable parts.

Incl. — Transistors, Condensers, Resistors, Heat Sinks, Diodes, Etc.

8 for \$1
100 for \$10

- 300 — ASSORTED HEX NUTS 2/56, 4/40, 5/40, 6/32, 8/32 .. \$1
- 250 — ASST. SOLDERING LUGS best types and sizes .. \$1
- 250 — ASST. WOOD SCREWS finest popular selection .. \$1
- 250 — ASST. SELF TAPPING SCREWS #6, #8, etc. \$1
- 150 — ASST. 6/32 SCREWS and 150 6/32 HEX NUTS .. \$1
- 150 — ASST. 8/32 SCREWS and 150-8/32 HEX NUTS .. \$1
- 150 — ASST. 2/56 SCREWS and 150-2/56 HEX NUTS .. \$1
- 150 — ASST. 4/40 SCREWS and 150-4/40 HEX NUTS .. \$1
- 150 — ASST. 5/40 SCREWS and 150-5/40 HEX NUTS .. \$1
- 500 — ASSORTED RIVETS most useful selected sizes .. \$1
- 500 — ASSORTED WASHERS most useful selected sizes .. \$1
- 100 — ASST. RUBBER BUMPERS for cabinet bottoms & other uses .. \$1
- 100 — ASSORTED RUBBER GROMMETS best sizes .. \$1
- ALL AMERICAN TUBE KIT 12RA6, 12HE6, 12AV6, 50C5, 35W4—total list \$9.70 .. \$2

- SOLID STATE UHF CONVERTER Receives channels 14-83. Easy connection to Your TV set .. \$16.95
- 3 — TOP BRAND 35W4 TUBES \$1
- UNIVERSAL MICROPHONE regular/remote/single & dual plug \$2
- CRYSTAL LAPEL MICROPHONE high impedance, 200-6000 cps ... \$5.95
- STEREO HEADPHONES Hi-Fi Quality... Complete with Stereo plug .. \$5.95
- 50 — TUBE CARTONS (colored) assorted sizes for Popular Tubes .. \$1
- 4 — 36" HI-FI CABLES RCA Molded Phone plug at one end stripped and tinned leads on other end .. \$1
- 3 JUMPER CABLES Male RCA 3 Type Plug on Both Ends, 2 for \$1.19
- 50 — ASST. TERMINAL STRIPS all types, 1-lug to 6-lug .. \$1
- 25 — INSTRUMENT POINTER KNOBS selected popular types .. \$1
- 1 — LB SPOOL ROSIN-CORE SOLDER 40/60 top quality .. \$1
- 3—ELECTROLYTIC CONDENSERS C.D. 500 mfd—200 volts .. \$1
- 3—ELECTROLYTIC CONDENSERS C.D.—250 mfd—350 Volts .. \$1
- 3—ELECTROLYTIC CONDENSERS most popular number 50/30—150v .. \$1
- 7 — TV ELECTROLYTIC CONDENSERS desirable types .. \$1
- 2—G.E. PIECES OF EQUIPMENT stacked with over 200 useful parts .. \$1

RCA 110° FLYBACK TRANSFORMER

We scooped the Market Latest type — standard for all 110° TV's

RCA's design of large Coil produces 18KV—assuring adequate width Incl Schematic Diagram application for any TV

List price \$13.90

Your price .. \$3
10% off in lots of 3

- 110° TV DEFLECTION YOKE for all type TV's incl schematic .. \$3
- "COMBINATION SPECIAL" RCA 110° FLYBACK plus 110° DEFLECTION YOKE \$5
- 90° FLYBACK TRANSFORMER for all type TV's incl schematic .. \$2
- 90° TV DEFLECTION YOKE for all type TV's incl schematic .. \$2
- 70° FLYBACK TRANSFORMER for all type TV's incl schematic .. \$2
- 70° TV DEFLECTION YOKE for all type TV's incl schematic .. \$2
- 2 — TV CIRCUIT BREAKERS Rated 4.2 TO 5.0 AMP's, etc. .. \$1.19
- 70° COLOR YOKE For all round color CRT's .. \$10.95
- 90° COLOR YOKE For all Rectangular 19 to 25" Color CRT's .. \$10.95

- MOTOROLA HEP KIT—INTEGRATED CIRCUITS INCLUDES —One J-K Flip Flop, One Dual Buffer, One 4-Input Gate, Two Dual 2-Input Gates, All Five \$3.95
- 2—MOTOROLA HEP-170 RECTIFIER 2 1/2 AMPS and 1000V PIV; Covers all 600MA to 2500MA White Voltage ranging from 50PIV to 1000 PIV .. \$1
- 3 — TOP BRAND SILICON RECTIFIERS 1 amp, 1000 PIV .. \$1
- 5 — I.F. COIL TRANSFORMERS 456-kc for Transistor Radios .. \$1
- 5 — AUDIO OUTPUT TRANSFORM Sub-min for Trans Radios .. \$1
- 5 — PNP TRANSISTORS general purpose, TO-5 case .. \$1
- 5 — NPN TRANSISTORS general purpose, TO-5 case .. \$1
- 50 — ASSORTED TRANSISTORS big factory scoop—sold as-is .. \$1
- METER SENTRY—SOLID STATE Protects meter movements up to 25 amp surge .. 99¢
- 10 — STANDARD TRANSISTORS NPN & PNP 2N404, 2N414, etc. .. \$1
- 10—ASSORTED DIODE CRYSTALS 1N34, 1N48, 1N60, 1N64, etc. .. \$1
- 4 — TV ALIGNMENT TOOLS most useful assortment #1 .. \$1
- 4 — TV ALIGNMENT TOOLS For Color TV #2 .. \$1.49
- 50 — ASSORTED MYLAR CONDENSERS popular selected types .. \$1

Circle 113 on reader service card

MODEL
4000

Mercury

FIELD EFFECT METER

COMBINES THE FINEST FEATURES OF THE
VTVM & VOLT-OHMS MILLIAMMETER



- .300 V. FULL SCALE DC
- LARGE 6" METER
- AC and BATTERY OPERATED
- HIGH IMPEDANCE (11 MEGS DC)
- 5 DC CURRENT RANGES

Solid State — so there's
NO WARM UP! • NO DRIFT!
• NO INTERNAL HEAT
TO UPSET STABILITY!
• ISOLATION FROM
AC LINE!

ONLY
79⁹⁵
WIRED

Includes: AC-OHMS/DC Probe
Power Requirements: 115 V 50/60 Hz, 3W
7 1/2 x 6 1/2 x 4 — 3 lbs.

All Mercury Test Equipment Guaranteed For One Full Year!
Write for complete catalog of Mercury Test and Repair
instruments, and name of your nearest dealer.

MERCURY ELECTRONICS CORPORATION
315 Roslyn Road • Mineola, N.Y. 11501 • (516) 742-5400
CANADA: William Cohen Corp. • 8900 Park Avenue • Montreal-11

Circle 114 on reader service card

NEW ENDECO Desoldering Kits

MODEL
300-K
KIT
SHOWN



All you need to handle
almost any desoldering
and resoldering job!



Kit 300K includes the famous Endeco pencil desoldering iron Model 300, six different size tips (.038 to .090) for any job, tip cleaning tool, and metal stand for iron . . . all in a handy lifetime steel storage box. \$19.90 net. Model 300K-3 with a 3-wire cord \$20.90. Also a similar kit for military users. Kit 100K with large Endeco iron (Model 100A) is \$27.40, and 3-wire Kit 100AD-3 \$28.40.

SEE YOUR DISTRIBUTOR OR WRITE



**ENTERPRISE
DEVELOPMENT
CORPORATION**

5149 E. 65th • Indianapolis, Ind. 46220
Circle 116 on reader service card

Precision
S
Line

Precision has led the field in quality and dependability for 25 years.

Greatest value in sound for every PA application

• Most trouble-free line in the industry, Precision offers a complete range of amplifiers in every power range including mobile, and a complete line of accessories. From the smallest office to large auditorium or industrial installations, Precision gives maximum flexibility and performance.

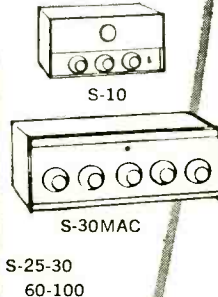

DIVISION OF PRECISION ELECTRONICS, INC.
9101 KING STREET, FRANKLIN PARK, ILLINOIS 60131

**MAIL THIS
COUPON
NOW!**

NAME _____
ADDRESS _____
CITY _____ STATE _____ ZIP _____

Circle 115 on reader service card



THOUSANDS
OF BARGAINS — TOP
VALUES IN Electronic Parts

Transistors,
Modules,
Speakers,
Stereo, Hi-Fi,
Photo Cells and
thousands of
other
Electronic
Parts. Send for
FREE
Catalog



ELECTRONIC DISTRIBUTORS INC.
Dept. TA-2, 4900 Elston
Chicago, Ill. 60630

RUSH CATALOG

Name _____
Address _____
City _____ State _____ Zip Code _____

Circle 117 on reader service card

RADIO-ELECTRONICS

TRY THIS ONE

THE INCH-EXPANDER

Wouldn't it be wonderful if that 8-inch speaker in the center channel or remote enclosure could sound as rich and full as the 12-incher in the main stereo unit? The Inch-Expander, with its ability to add an apparent full octave to the range of any good 8-inch speaker, may be just the gadget you are looking for.

The Inch-Expander (see diagram) is a simple low-pass

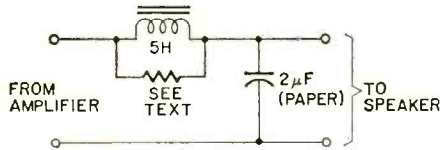

filter with a relatively fixed impedance over the middle and high frequencies and a much lower impedance over the all important bass octaves. Some power is lost in the resistor, but the added bass more than compensates for this inefficiency.

The components can be mounted in a small utility box or within the speaker enclosure. The resistor value should approximate the speaker's impedance. I use 3 ohms for 4-ohm speakers, and 7.5 and 15 ohms for 8- and 16-ohm speakers, respectively.—*P. Rodger Magroney*

SIMPLE CAPACITOR CHECKER

This simple capacitor spots open units and leakage that can't be detected with a vom. It checks disc, mica and tubular units. All you have to do is watch the neon lamp as you connect the test leads across the capacitor.

Good capacitors will show a single flash of light on the initial charge. The flash will be faint on smaller capacitor values. On larger units, the lamp glows until the capacitor is fully charged. The capacitor is open if the lamp does not flash. Intermittent or continued flashing indicates the capacitor is leaky.—*L. E. Keene, Jr.*

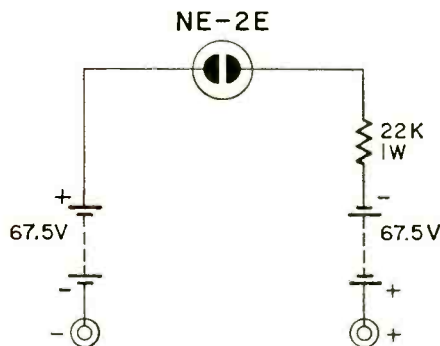

(You can use this checker for electrolytics if you watch polarity and operating voltage. Around 135 volts is applied to the capacitor under test so you cannot use it on low-voltage types used in transistor equipment.)

When checking electrolytics, the lamp glows brightly and then dims until it goes out. It will then begin to flash. All electrolytics have some leakage and will cause the lamp to flash. If it flashes more than once a second, the capacitor is too leaky to use. A flash-rate of once per second or longer shows that the capacitor is good.—*Editor*

R-E

Fast easy soldering is a gift from

Weller®

Give a Weller soldering tool for Christmas and you give a man the ability to make secure soldered connections quickly and easily. And because no other soldering tools match Weller for features and dependability, you know you're giving the best.



8-Piece Dual Heat Soldering Gun Kit

Gun tip heats instantly when trigger is pulled. Two trigger positions for instant switching to high 140 watt or low 100 watt heat. Built-in spotlight. Included: 3 soldering tips, tip wrench, flux brush, soldering aid, solder, plastic case. Model 8200PK. **\$9.95** list



New TEMPMATIC® Temperature Controlled Soldering Tool

Combines all the advantages of a fast heating soldering gun, a lightweight pencil iron and tip temperature control. Gives maximum component protection in the most delicate work situations. Yet it does heavy jobs like chassis soldering. Weighs only 7 ounces. Powerhead contains Weller's temperature control system. Model GT-7A has 700°F. 3/16" chisel point Powerhead. Model GT-6B has 600°F. conical 3/16" point Powerhead. Each tool—**\$12.98** list

Weller MARKSMAN Soldering Iron Kit

Lightweight 25-watt iron outperforms all other irons of its size and price. Has replaceable tip, stainless steel barrel, cool handle. Included: 2 extra tips, soldering aid, solder. Model SP-23K. **\$4.44** list



WELLER ELECTRIC CORPORATION, EASTON, PA.
WORLD LEADER IN SOLDERING TOOLS

Circle 118 on reader service card

If you know electronics... you should know what a C. D. ignition system will do for your automobile's performance index.



You should also know the leader among C.D.'s is the **TIGER SST**

You can give your car more sparkling performance and improve economy at the same time. TIGER SST makes possible complete fuel combustion which means greater acceleration, higher top speed, increased spark plug life (up to 100,000 miles), instant cold weather starting and a mileage increase of as much as 15%. Enthusiastic users report an immediate and dramatic improvement in both performance and economy.

Now you can give your car or truck the liveliness you've always wanted. And it's available at low cost - fuel savings and the elimination of tune-ups alone will repay the cost in only a few months.

TIGER SST is backed by nearly a decade of experience in the capacitive discharge ignition field. Such research and development means that your vehicle can have the ultimate in ignition—the kind which is only now being made available by the Detroit manufacturers as an expensive additional option.

In kit form, TIGER SST requires less than an hour of fabrication and installation time... fully assembled it can be operational in less than ten minutes. All needed wiring, connectors and fasteners are supplied—you use your present coil and spark plug wires.

Step up to better performance now; clip, fill out and mail the coupon below today.



Delta International Ltd.
Post Office Box 1946 EWO 81501
Grand Junction, Colorado

Enclosed is my check (or money order) for \$_____. Please rush prepaid:

SIMPLI-KIT TIGER SST \$28.95
ASSEMBLED TIGER SST \$39.95

MAKE OF CAR _____ YEAR _____

NAME _____

ADDRESS _____

CITY _____ STATE _____

*Passage prepaid in U.S. and Canada only

Circle 119 on reader service card

Service Clinic

By JACK DARR
SERVICE EDITOR

Raster size and brightness

After my RCA CTC17 color set has been on for about a half hour, the picture starts to get dim and loses size. Finally it goes clear out. Focus is poor, too, at all times. What causes this?—K. N., Dallas, Tex.



GOING → GOING → GONE

put. This set uses a bridge-rectifier circuit with silicons. Silicons do not normally "get weak," as the original seleniums did. When they fail, they usually short out completely. A gradual drop in the dc supply voltage would probably be due to the input filter capacitor losing normal storage capacity.

Monitor the +405-volt dc supply. If the dc supply goes down, the boost will go with it. If the picture goes out and the dc supply voltage stays the same or even rises a little (due to reduced current drain), check the boost voltage.

Since the focus is a percentage

TECHNI-TOOL, INC.
1216 ARCH ST., PHILA., PENNA.
ZIP CODE: 19107-(215) LO 8-4457

#4916 DUAL INLINE PACKAGE EXTRACTION

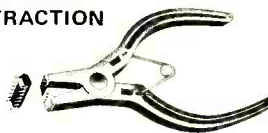

The first of a family of tools for the latest in integrated circuitry. Removes 4-64 pin D.I.P.'s.

Now available for immediate delivery.

SCREWDRIVERS



Nutdrivers, many types and styles to choose from. Custom sets are available. Name Brands. Immediate delivery.

ASSEMBLY KITS

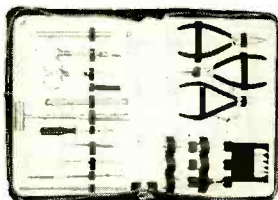

12 standard kits to choose from. Specials available.

TOOLS FOR ELECTRONICS

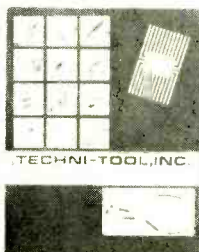

NEW CATALOG #16

New for the 70's. Over 5,000 items to choose from.

Send 25¢ for Handling

NAME

TITLE

COMPANY

ADDRESS

CITY STATE ZIP

Circle 120 on reader service card

Let's go back to basics. This symptom shows a power supply loss; notice that you lose height, width and brightness simultaneously. The cause must be something common to all three, and this is the power supply.

It could be your boost voltage (a weak damper tube, for instance) or it could be a gradual drop in the B+ dc supply voltage, due to a partially open filter capacitor such as the 80-F input filter at the rectifier out-

put. This set uses a bridge-rectifier circuit with silicons. Silicons do not normally "get weak," as the original seleniums did. When they fail, they usually short out completely. A gradual drop in the dc supply voltage would probably be due to the input filter capacitor losing normal storage capacity.

Monitor the +405-volt dc supply. If the dc supply goes down, the boost will go with it. If the picture goes out and the dc supply voltage stays the same or even rises a little (due to reduced current drain), check the boost voltage.

Since the focus is a percentage

WHY PAY MORE?

You can buy for LESS at Edlie's
Be sure to send for our

FREE MONEY SAVING CATALOGUE
HERE ARE JUST A FEW OF OUR SPECIAL **BUYS**

G.E. Four Track Stereo Tape Deck
Push button control—complete in operating condition except for face plate \$19.95

TRANSDUCER 200 K. C.

Made by Brush. Brand new. For use with Marine Depth Finder Equipment or experimental purposes. PRICE ONLY \$2.95

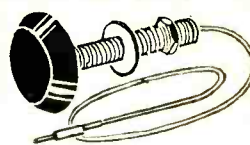

S. C. R. BOARDS

Type A contains the following: 1-12A, 200 P.I.V. S.C.R.; 1-transistor; 4 resistors; 2-diodes. PRICE 99¢ ea; 6 for \$5.00
Type B contains the following: 1-12A, 200 P.I.V. S.C.R.; 3-transistors; 1-100 ohm trimpot; 10-resistors; 2-diodes. Price —\$1.39

Paco ST-26 FM TUNER-AMP. KIT

Comes complete with a 66 page assembly and operating Manual for building this fine kit. Complete with 6 tubes and all major parts. It is complete in every detail except for a few minor parts such as miscellaneous hardware which can be easily obtained. Has output for stereo multiplex adaptor. Price for this FM tuner & amplifier kit only \$14.95 Cabinet not included.

WESTINGHOUSE solid state MULTIPLEX ADAPTERS \$3.95

Terms of sale: Full payment or 20% with order. Minimum order \$2.00

Write for FREE 1969 Catalog.

EDLIE ELECTRONICS INC. Dept. RE-12
2700 Hempstead Tpke., Levittown, N.Y. 11756

Circle 121 on reader service card

RADIO-ELECTRONICS

of the high voltage, this could be affecting it, too. Focus voltage should be about 4500 with 24 kV of high voltage.

Low volume in auto reverberation unit

I just installed an auto radio reverb unit in a car with a built-in rear-seat speaker. I can't get much volume out of the rear-seat speaker, and have no reverb effect. Could this be the fader in the original radio circuit?—D. H., Shuylkill Haven, Pa.

Probably something in the switching. In standard reverb units, the rear-seat speaker can be switched on alone, with the front speaker or cut out. A reverb works with the rear-seat speaker *only*.

Each reverb unit has its own small amplifier. The rear-seat speaker input is switched to the input of the reverb amplifier, and the rear-seat speaker is then connected to the reverb's output. To get the reverb effect, the signal must go through the reverb unit on its way to the rear-seat speaker. Check your wiring and switches. **R-E**

TRANSISTOR CURVE TRACER (continued from page 78)

shows the effect of high temperatures caused by excessive sweep voltage. The lower photo was taken after the condition was corrected and the transistor had cooled down.

The 40481 is a four-lead rf-type transistor in which the fourth lead is connected to the case. Distortion is quite evident in the lower bias curves (Fig. 7).

The actual Zener voltage of the 12-volt Zener (top, Fig. 8) is seen as 12.2 volts and has a sharp Zener characteristic. The knee of the 3.3-
(continued on page 95)

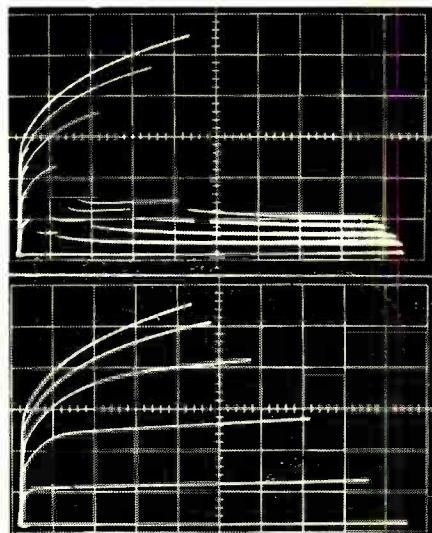

Fig. 7—Distortion is obvious.

FREE!



BRAND NEW EDITION 1970 Catalog 700

Serving The Public
Since 1920

Featuring Everything in Electronics for
• HOME • INDUSTRY • LABORATORY
from the "World's Hi-Fi & Electronics Center"



496 Pages

- Electronic Parts... Tubes...
- Tools
- Citizens Band Equipment
- PA Equipment
- Test Instruments
- Closed Circuit TV
- Stereo Hi-Fi Systems & Components
- Tape Recorders
- Amateur Radio Equipment
- Radio & TV Sets & Accessories
- Cameras & Supplies
- Books

LAFAYETTE RADIO ELECTRONICS

Dept. 17109

SYOSSET, L.I., N.Y. 11791

Send For **FREE**
1970 Catalog
TODAY

Send **FREE** 1970 CATALOG 700

17129

Name.....

Address.....

City..... State..... Zip.....

Circle 122 on reader service card

U.S. GOV'T ELECTRONIC SURPLUS

• Nationally Known—World Famous SURPLUS CENTER offers finest, most expensive, Government Surplus electronic units and components at a fraction of their original acquisition cost.

ORDER DIRECT FROM AD or WRITE FOR CATALOGS

COMPUTER TRANSISTORS ON HEAT SINKS

IBM Computer Quality Units

• (#22-928) -- Unit consists of one 150-watt power transistor, 3 poles, several diodes, capacitors, resistors, etc. on heavy, ribbed aluminum heat sinks. Many experimental uses. (1 lb.)
Cost Gov't Over \$10.00 **\$1.99**

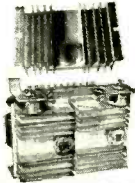

• (#22-915) -- Unit consists of two 150-watt power transistors, 3 poles, several diodes, capacitors, resistors, etc. on heavy, ribbed aluminum heat sinks. Ideal for use as audio speed controls. (4 lbs.)
Cost Gov't Over \$35.00 **\$4.91**

RUNNING TIME METER

• (#DX-104) -- Use to record number of operating hours of electric lights and electrical devices such as refrigerators, furnaces, etc. Records total hours, tenths and hundredths up to 9,999.99 hours. For 115-volt, three-electrode size 4 1/2" x 3" x 2 1/2". Shipping weight 2 lbs.
\$5.69 Cost Over \$29.00



12 and 24-VOLT TRANSFORMER

• (#15-920) -- General Electric 115-volt, 60-cycle to 12 and 24-volts @ 750-watts. Capacitive 42-amps, @ 24-volts, 64-amps, at 12-volts. Useful for battery chargers, running DC motors, etc. 7" x 5" x 5". (18 lbs.)
Cost Gov't Over \$15.00 **\$16.72**

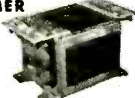

EXPANDED SCALE 0 - 15 DCVM

• (#21-800) -- Brand new, expensive voltmeter reads 0-15 volts DC and 0-15 volts AC. Very useful for automotive and aircraft battery charge indicator, etc. Manual movement, black phenolic case. 7" x 5" x 2 1/2". (3 lbs.)
List \$32.50 **\$12.95**



SURPLUS TELETYPEWRITERS

Orig. Cost Over \$1500.00

SPECIAL **\$249.50**

• (ITEM #22-936) -- Used but excellent teleprinters. Model 13 complete with A.S. Co. Data-com. Permits using teleprinter over regular long distance communication. Complete with AC power supply, control telephone, etc. Wt. 160 lbs. Size 24" x 22" x 42".
• Also have limited number Model 19 Teleprinters with perforator, Data-com, etc. Write for Sale price.



SEND 25c COIN OR STAMPS FOR CATALOGS
All Items FOB Money Back Guarantee

SURPLUS CENTER

DEPT. RE 129 LINCOLN, NEBR. 68501

Accuracy like a VTVM... Convenience like a VOM...

NEW BATTERY-OPERATED FET SOLID-STATE VOLT-OHMMETER #116

Easy-to-build KIT

\$29⁹⁵ # 116K

Factory-Wired & Tested

\$39⁹⁵ # 116W

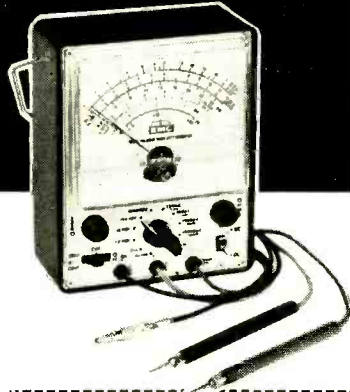

Now you can get all the benefits of a VTVM (laboratory accuracy, stability and wide range) but with its drawbacks gone: no plugging into an AC outlet, no waiting for warm-up, no bulkiness. New Field Effect Transistor (FET) design makes possible low loading, instant-on battery-operation and small size. Excellent for both bench and field work.

Compare these valuable features:

- High impedance low loading: 11 meg-ohms input on DC, 1 megohm on AC
- 500-times more sensitive than a standard 20,000 ohms-per-volt VOM
- Wide-range versatility: 4 P-P AC voltage ranges: 0-3.3, 33, 330, 1200V; 4 RMS AC voltage ranges: 0-1.2, 12, 120, 1200V; 4 DC voltage ranges: 0-1.2, 12, 120, 1200V; 4 Resistance ranges: 0-1K, 0-100K, 0-10 meg., 0-1000 meg.; 4dB ranges: -24 to +56dB.

Sensitive easy-to-read 4½" 200 micro-amp meter. Zero center position available. Comprises FET transistor, 4 silicon transistors, 2 diodes. Meter and transistors protected against burnout. Etched panel for durability. High-impact bakelite case with handle useable as instrument stand. Kit has simplified step-by-step assembly instructions. Both kit and factory-wired versions shipped complete with batteries and test leads. 5¼" H x 6¾" W x 2⅞" D. 3 lbs.

Send FREE catalog of complete EMC line and name of nearest distributor. RE-12

Name _____
Address _____
City _____
State _____ Zip _____

EMC

ELECTRONIC MEASUREMENTS CORP.
625 Broadway, New York, N.Y. 10012
Export: Pan-Mar Corp., 1270 B'way, N.Y. N.Y. 10001

JACK IN THE BOX

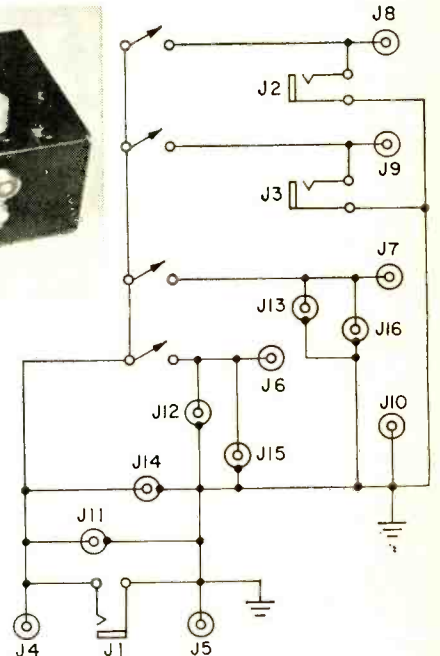
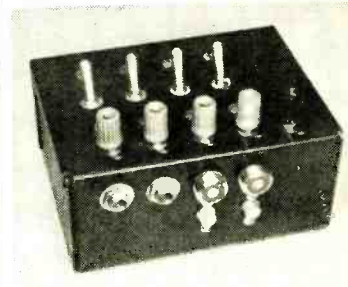

- J1-J3 — SINGLE-CIRCUIT PHONE JACKS
- J4-J10 — BANANA JACKS OR 5-WAY BINDING POSTS
- J11-J13 — RCA-TYPE PHONO JACKS
- J14-J16 — MICROPHONE JACKS

This Jack in the Box is a handy accessory with many uses. It can be used as a universal adaptor to temporarily couple dissimilar plugs and connectors during tests on equipment. Also for A-B comparison testing of amplifiers, microphones, speakers, crossovers or other equipment. A scope may be plugged in for visual examination during tests. For example 4 different speakers can be connected to the multiple input side and an amplifier to the single input side. The speakers can then be switched alternately for instant comparison of sound quality. Or with more than one amplifier connected and one speaker for amplifier comparison. Turn the volume down on amplifiers that are switched out. Microphones may be compared the same way.

Construction should be in a metal box (see photos) to provide shielding. The binding posts should be spaced to take dual banana plugs on the ground and adjoining post. As many jacks or types can be used as needed. Also the number of switches used depends on your needs.—Arthur T. Grahn

R-E

there's no end to what Master flameless heat guns can do

fast adjustable heat to 1,000° F.

- Shrinks tubing, molds or welds plastics, dries finishes, etc.
- Adjustable orifice allows precise temperature regulation.
- Switches from hot to cool air instantly.
- Takes a variety of air flow adapters to match any job.

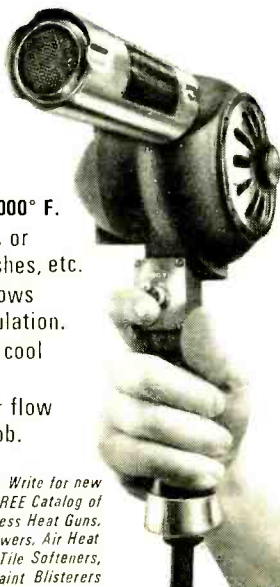

Write for new
FREE Catalog of
Flameless Heat Guns,
Blowers, Air Heat
Torches, Tile Softeners,
Paint Blisterers

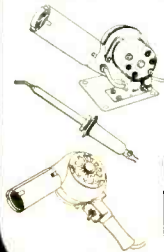

Master
appliance corporation
Racine, Wisconsin 53403

Circle 124 on reader service card

TRANSISTOR CURVE TRACER
(continued from page 93)

volt Zener (bottom, Fig. 8) is comparatively rounded and does not reach its nominal voltage rating until

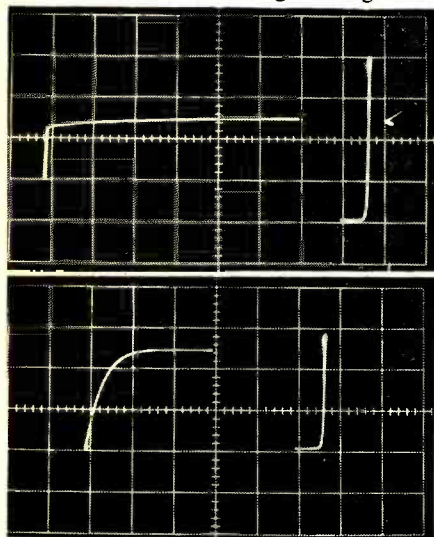

Fig. 8—Top photo shows 12V Zener voltage; bottom shows 3.3V Zener curves.

after the current increases to about 12 mA. The forward and reverse conduction curves are obtained separately, though shown in the same photo. R-E

STATEMENT OF OWNERSHIP, MANAGEMENT AND CIRCULATION, Act of October 23, 1962, Section 4369, Title 39, United States Code.)

1. Date of filing: October 1, 1969
2. Title of publication: RADIO-ELECTRONICS
3. Frequency of issue: Monthly
4. Location of known office of publication: Ferry Street, Concord, Merrimack County, New Hampshire 03302.
5. Location of the headquarters or general business offices of the publishers: 200 Park Avenue South, New York, New York 10003.
6. Names and addresses of publisher, editor, and managing editor: Publisher, M. Harvey Gernsback, 200 Park Avenue South, New York, New York 10003; Editor M. Harvey Gernsback, 200 Park Avenue South, New York, New York 10003; Managing Editor, Larry Steckler, 200 Park Avenue South, New York, New York 10003.
7. Owner: Gernsback Publications, Inc., 200 Park Avenue South, New York, New York 10003; M. Harvey Gernsback, 200 Park Avenue South, New York, New York 10003; Mary H. Gernsback, M. Harvey Gernsback, Maurice Coyne, Benjamin E. Winston As Trustees Under Trust Agreement dated September 30, 1965. c/o Benjamin E. Winston, Esq., 2 W. 45 St., New York, New York.
8. Known bondholders, mortgagees, and other security holders owning or holding 1 percent or more of total amount of bonds, mortgages or other securities: None.
9. For completion by nonprofit organizations authorized to mail at special rates: Does not apply in this case.
10. Extent and nature of circulation. Average number of copies each issue during preceding 12 months are: (A) Total No. of copies printed (net press run): 218,550; (B) Paid circulation: (1) Sales through dealers and carriers, street vendors and counter sales: 43,972; (2) Mail subscriptions: 109,971; (C) Total paid circulation: 153,943; (D) Free distribution (including samples) by mail, carrier or other means: 1,769; (E) Total distribution: 155,712; (F) Office use, left-over, unaccounted, spoiled after printing: 62,838; (G) Total: 218,550. The number of copies of single issue nearest to filing date: (A) Total number copies printed (net press run): 207,112; (B) Paid circulation. (1) Sales through dealers and carriers, street vendors and counter sales: 43,001; (2) Mail subscriptions: 105,013; (C) Total paid circulation: 148,014; (D) Free distribution (including samples) by mail, carrier or other means: 1,670; (E) Total distribution: 149,684; (F) Office use, left-over, unaccounted, spoiled after printing: 57,428; (G) Total: 207,112.

I certify that the statements made by me above are correct and complete.
(Signed) M. Harvey Gernsback Publisher

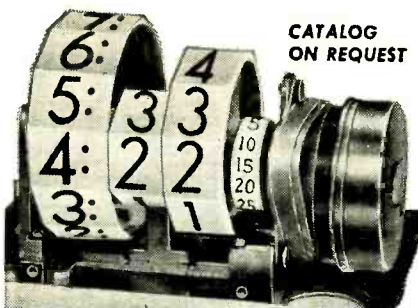

CATALOG ON REQUEST



CLOCK MOVEMENTS

DIGITS RESETTABLE INDIVIDUALLY

Available in 50, 60 cy., all voltages, AC. UL approved motor, cord. One Year Guarantee.

#130...12-HOUR #131...24-HOUR

Tymeter #90
Direct Read-Out Interval
TIMER

by seconds,
minutes, 1/4 hr.,
1/2 hr., hour

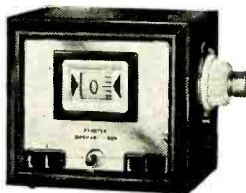

Made in U.S.A.

Complete Line: Delay, Interval
and Cycle Timers, Digital Computers

PENWOOD NUMECHRON CO.
TYMETER ELECTRONICS

7249 FRANKSTOWN AVE., PITTSBURGH, PA. 15208

Circle 125 on reader service card

**SAVE ON EVERYTHING
IN ELECTRONICS!**

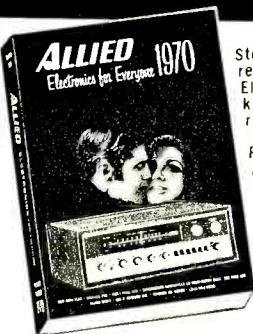

Stereo hi-fi • Tape recorders & tape • Electronic & hobby kits • CB 2-way radios • Radios • Shortwave • Phonographs • Amateur gear • Automotive electronics • Tools & hardware • Tubes, transistors, parts, batteries, books and more! . . .

FREE 552-PAGE ALLIED 1970 CATALOG

Right off the press and crammed with values—our biggest catalog ever! Huge selections, low prices, fast service. Mail coupon below for your free copy. Hurry, while they last!

.....
ALLIED RADIO, Dept. 539 Please
P.O. Box 4398, Chicago, Ill. 60680 Print

 NAME First Middle Last

 STREET ADDRESS or ROUTE & BOX NO.

 CITY

 STATE ZIP

Circle 126 on reader service card

**There's no substitute
for SUCCESS...**



JAMES WONG—Research Engineer
Heald Engineering College Graduate

or IN-CLASS INSTRUCTION!

In electronics, it's the training that makes the difference. Employers require well-trained men and the first thing checked is where you gained your knowledge.

HEALD GRADUATES have many job offers with starting salaries often in excess of \$10,000 per year. AND advancement is rapid.

GET STARTED NOW. Be a
 DRAFTSMAN—12 months
 TECHNICIAN—15 months
 ENGINEER (B.S. Deg.)—36 months
 ARCHITECT (B.S. Deg.)—42 months
 YOU are eligible for HEALD ENGINEERING COLLEGE if you have a high school education or the equivalent.

Increased income starts with success—success starts with your move to Heald. Send now for FREE brochures with more information on Heald in San Francisco and your future in Engineering.

FREE LIFETIME PLACEMENT SERVICE
VETERAN APPROVED



WRITE TODAY FOR DETAILS

HEALD Engineering College

1215 Van Ness Ave., San Francisco, California 94109

Please send me information about:

- ARCHITECTURE
 ENGINEERING: Civil Electrical
 Electronic Mechanical
 TECHNOLOGY: Electronic Engineering
 Technician (FCC)
 Radio-Television Technician (FCC)
 DRAFTING: Mechanical Electrical
 Structural

I am interested in Day Evening courses
 Also send an application.

NAME _____ ABE _____
 ADDRESS _____
 CITY _____
 STATE _____
 ZIP _____ PHONE _____

Circle 127 on reader service card

MARKET CENTER

AUDIO - HI-FI

Tapemates makes available to you ALL 4-TRACK STEREO TAPES. All labels—postpaid to your door—at tremendous savings. For free brochure write: **TAPEMATES CLUB**, 5280 RE West Pico Blvd., Los Angeles, Calif. 90019.

TAPE RECORDER SALE. Brand new nationally advertised brands, \$10.00 above cost. Amazing discounts on stereo components. **ARKAY ELECTRONICS**, 1028-E Commonwealth Avenue, Boston, Mass. 02215

WRITE for highest discounts on components, recorders, tapes, from franchised distributors. Send for FREE monthly specials. **CARSTON**, RFD #3, Route 7, Brookfield, Conn. 06804

RENT 4-track open reel tapes—all major labels—3,000 different—free brochure. **STEREO-PARTI**, 55 St. James Drive, Santa Rosa, Ca. 95401

ELECTRONICS

TUBES—LOWEST PRICES in the world. Hard to get British, German, foreign and American obsolete and present day special purpose transmitting tubes. Send for giant tube and parts catalog. **UNITED RADIO CO.**, Dept. R-56, Ferry St., Newark, N.J. 07105

RECEIVING & INDUSTRIAL TUBES, TRANSISTORS, All Brands—Biggest Discounts. Technicians, Hobbyists, Experimenters—Request FREE Giant Catalog and SAVE! **ZALYTRON**, 469 Jericho Turnpike, Mineola, N.Y. 11501.

Discharge **IGNITION, PHOTOFASH.** Free catalog parts, kits. **TRANSPARK**, Carlisle, Mass. 01741

CONVERT any television to sensitive Big-Screen Oscilloscope. Only minor changes required. No electronic experience necessary. Illustrated plans \$2.00. **RELCO-A25**, Box 10563, Houston, Texas 77018

FREE Catalog OF THE WORLD'S FINEST GOV'T SURPLUS ELECTRONIC BARGAINS

Now **BIGGER and BETTER** Than Ever!

---MAIL THIS COUPON NOW---

NAME: _____

ADDRESS: _____

CITY: _____ STATE: _____ ZIP: _____

For your FREE copy, fill out coupon and mail, Dept. RE

FAIR RADIO SALES
1016 E. EUREKA • Box 1105 • LIMA, OHIO • 45802

CONTROL CENTERS
Switch Speakers!

For Stereo, Hi-Fi, Mixing, Monitoring!

1st Time!

Also Control Center allows your choice of up to 6 stereo speaker systems to be selected simultaneously. Push-on & push-off switches enable you to optionally select your choice of speaker pairs. Easy access rear panel connectors to match your particular system. No external power required; no impedance match problems. Useable with low or high impedance circuits. Leather-styled black metal with brushed aluminum trim. 7 1/2" x 2 1/4" x 8 1/16". For home or professional use.

Model	No. Prs.	Connector Type	Each
CC4RCA	4	RCA	\$19.95
CC4PHM	4	Phone (Miniature)	21.95
CC4PHS	4	Phone (Standard)	22.95
CC6RCA	6	RCA	26.95
CC6PHM	6	Phone (Miniature)	28.95
CC6PHS	6	Phone (Standard)	29.95

ORDER BY MAIL — CHOICE OF 6 MODELS

ALCO Buy Direct: BOX 1348RE LAWRENCE, MASS. 01842

RECHARGEABLE EVEREADY NI-CAD BATTERIES

9V (8.75V) 1/2 amp. hr. cap., size 2 1/2" long x 1 1/4" diam. Made of 7-N38 or BH 500 button cells. Suitable to power cameras, elect. flash, phonos, radios, exp. power supplies, many other uses. Retail value \$12.00 ea. A fortunate purchase permits selling these life time batteries on a money back guarantee basis at a fraction of cost. Postpaid at \$2.95 ea. (6 for \$15.00)

Miniature Swiss, permanent magnet precision motor, reversible, (escap) 1-6 volts D C with reduction gear 50 rpm. High torque \$1.95 ea.

TECHNICAL MATERIALS COMPANY
769 Inwood Road — Union, N.J. 07083
Phone 201-687-9172 — 201-687-5171

ENJOY THE "MUSIC ONLY" FM PROGRAMS

M. A. D.

MUSIC ASSOCIATED'S DETECTOR
for continuous, commercial-free music with ANY FM tuner or receiver



Kit \$49.50 Wired \$75.00 Cover \$4.95 List of FM stations with SCA authorization \$1.00. For complete information write or call:

MUSIC ASSOCIATED
65 Glenwood Rd.
Upper Montclair, N.J. 07043
phone 201-744-3387

ADVERTISING INDEX

RADIO-ELECTRONICS does not assume responsibility for any errors which may appear in the index below.

READER SERVICE CARD NO.	PAGE
16	Accurate Instrument Co., Inc. 15
126	Allied Radio Corp. 95
29	Audionics, Inc. 32
35	B & K (Division of Dynascan Corp.) .. 74
113	Brooks Radio and TV Corp. 88-89
112	Burstein-Applebee Co. 89
11	Castle TV Tuner Service 7
31	Cleveland Institute of Electronics .. 64-67
26	Concord Electronics Corp. 26
	CREI, Home Study Division of McGraw-Hill Book Co. 18-21
119	Delta International, Ltd. 92
22	Delta Products, Inc. 23
121	Edlie Electronics Inc. 92
117	Electronic Distributors, Inc. 90
8	EICO Electronic Instrument Co., Inc. Cover II
	EMC Electronic Measurement Corp. .. 94
	Electronics and Control Engineers' Book Club 1
25	Electro-Voice, Inc. 25
116	Enterprise Development Corp. 90
17	Essex International, Inc., Controls Division, Stancor Inc. 16
33	Finney Co. 72
149	GBC Closed Circuit Corp. Cover III
34	Gratham School of Electronics 73
115	Grommes Precision Electronics 90
127	Heald Engineering College 95
110	Heath Co. 84-87
148	International Crystal Mfg. Co. 100
13	Intratec 12
19	JFD Electronics Corp. 17
27	Johnson Co., E.F. 27
122	Lafayette Radio Electronics 93
10	Mallory Distributor Prod., Inc. 5
124	Master Appliances Corp. 94
114	Mercury Electronics Corp. 90
108	Multicore Sales Corp. 82
	National Radio Institute 8-11
	National Technical Schools 28-31
107	Olson Electronics, Inc. 82
15	Oxford Transducer Corp. 14
125	Pennwood Numechron Co. 95
	RCA Electronic Components Tubes Cover IV
	RCA Institutes 46-49
14	RCA Parts & Accessories 13
32	RCA Test Equipment 71
24	Rye Industries, Inc. 24
111	S & A Electronics 88
23	Sansui Electronics Corp. 24
37	Schober Organ 78
100	Scott, Inc., H.H. 16
21	Secore 22
36	Secore 77
106	Sonar Radio Corp. 82
	Surplus Center 93
120	Techni-Tool 92
118	Weller Electric Co. 91
109	Xcelite, Inc. 83
	MARKET CENTER 96-99
139	Alco Electronic Products, Inc.
	Arcturus Electronics Corp.
137	Bele Electronics
	Edmund Scientific Co.
	Fair Radio Sales
	McGee Radio Co.
	Music Associated
138	Park Electronic Products
140	Poly Paks
136	Solid State Sales
	Technical Materials Co.
	Viking Detectors
	SCHOOL DIRECTORY 98
	Tri-State College
	Valparaiso Technical Institute

INTEGRATED CIRCUITS RECTIFIERS SEMICONDUCTORS TRIACS

TRIACS

PVR	5 AMP	10A
100	.90	1.20
200	1.40	1.75
300	1.75	2.25
400	2.25	2.75
500	2.60	3.25

ER900 TRIGGER DIODES. These bidirectional trigger diodes are one of the best and cheapest methods to trigger SCR's and triacs 3/\$1.00

UNIUNCTIONS!

Similar to 2N2419. RBB of 5-7 stand off ratio of .6 and Ip of 12 with data sheet SPECIAL \$1.00

ZENERS 750 milliwatt 7-68V \$.40
10 Watt 7-180V \$.75

MOUNTING HARDWARE KITS.

These kits are used to mount our SCR's Zeners and Rectifiers etc. 6x32 stud (3, 12 amp rectifiers, 7A SCR's) 6 sets/\$1.00

¼x28 stud (30 amp. rectifiers, 20 amps SCR's.) 4 sets/\$1.00

□ 2N1163 a TO-3 PNP GERMANIUM TRANSISTOR rated at 35v and a gain of 50 at 25 amps. \$1.75

□ N-CHANNEL FET'S TO-18 plastic units, low noise, low leakage, 25 volts source to gate, 50 ma gate current Gain to 9000 µmho's. \$.80

□ NEON LIGHT OR NIXIE TUBE DRIVERS. An NPN, TO-18, Si Transistor. With a VCBO of 120 3/\$1.00

Silicon Power Rectifiers

PRV	3A	12A	30A
100	.09	.30	.50
200	.16	.50	.80
400	.20	.70	1.20
600	.30	1.00	1.50
800	.40	1.25	1.80
1000	.50	1.50	2.20

Terms: FOB Cambridge, Mass.

Send check or Money Order. Include Postage. Average Wt. per package ½ lb. No C.O.D.'s. Minimum Order \$3.00

WE LEAD THE WAY IN SERVICE AND QUALITY

Send for our latest catalog featuring Transistors and Rectifiers; 325 Elm St., Cambridge, Mass.

9030 8 BIT MEMORIES\$3.95

LINEAR CIRCUITS

CA 3011 FM-IF AMPLIFIER \$.90
702C WIDE BAND DC AMPL. \$1.75 ea.
709C OPERATIONAL AMPL. \$1.75 ea.
710C HI SPEED DIFF. AMP. \$1.75 ea.
711C DUAL COMPARATOR \$1.75 ea.

DIGITAL RTL CIRCUITS

2-914 QUAD 2 input gates \$1.25
900 Buffer \$.75
925 Dual 2 input gate expander \$.75
923 JK flip flop \$1.00
2-923 Dual JK flip flop \$1.50

Controlled Avalanche or Epoxy Rectifiers 1 AMP.

PRV	PRV
100	.07
200	.09
400	.11
600	.18
800	.22
1000	.35

Silicon Control Rectifiers

PRV	3A	7A	20A	70A
50	.35	.45	.70	
100	.50	.65	1.00	4.00
200	.70	.95	1.30	8.00
300	.90	1.25	1.70	
400	1.20	1.60	2.10	12.00
500	1.50	2.00	2.50	
600	1.80	2.40	3.00	16.00
700	2.20	2.80		

Ultra-sensitive and powerful METAL DETECTORS join the many who are finding buried coins, minerals, relics and artifacts. Don't buy till you see our free catalog of new models. Write JETCO—Box 132-RE, Huntsville, Texas 77340

RADIO & TV TUBES 33¢ each. One year guaranteed. Plus many unusual electronic bargains. Free catalog. CORNELL 4217-E University, San Diego, California 92105

IGNITION COILS 400:1 turns ratio, metal case, heavy duty. Limited offer \$5.00 each, 2 for \$8.00. CARY ENGINEERING, Box 6559, San Diego, Calif. 92106

BURGLAR AND FIRE ALARM SYSTEMS and supplies. Installation manual and catalog \$1.00. Refund on first order. ELECTRONIC SENTRY SYSTEMS, P.O. Box 8023B, Sacramento, Cal. 95818

OSCILLOSCOPE IMPROVEMENT KITS. High speed Triggersweep eliminates sync problems. Dual-trace FET switch displays two waveforms together. SOLID-STATE SERVICES, P.O. Box 901, Cupertino, California 95014.

INTEGRATED CIRCUIT KITS: computer, audio, others. New catalog free. KAY ENGINEERING, Box 3932-D, Long Beach, California 90803.

SCHEMATICS, DIAGRAMS, old radios, TVs, \$1.50. GORDIES TV, Hustisford, Wis. 53034

JAPAN & HONG KONG DIRECTORY. Electronics, all merchandise. World trade information. \$1.00 today. IPPANO KAISHA LTD., Box 6266, Spokane, Washington 99207

SPECIAL CLEARANCE SALE: Rectifiers, transistors, and many other electronic parts. Lowest prices! Free catalog. GENERAL SALES COMPANY, 254 Main, Clute, Texas 77531

EDUCATION/ INSTRUCTION

R.E.I.'s famous (5) week course for the first RADIO TELEPHONE LICENSE in the shortest, most effective course in the nation. Over 98% of R.E.I. graduates pass F.C.C. exams for 1st class license. Total tuition \$360.00. Job placement free. Write for brochure. RADIO ENGINEERING INCORPORATED SCHOOLS, 1336 Main Street, Sarasota, Florida 33577 or 3123 Gillham Road, Kansas City, Missouri 64109 or 809 Caroline Street, Fredericksburg, Virginia 22401 or 625 E. Colorado Street, Glendale, California 91205

FCC First Class License in six weeks—nation's highest success rate—approved for Veterans Training. Write ELKINS INSTITUTE, 2603E Inwood Road, Dallas, Texas 75235

FREE TV TUNER REPAIR TRICKS. Plans, details, complete courses. FRANK BOCEK, Box 833, Redding, Calif. 96001

WANTED

QUICK CASH . . . for Electronic EQUIPMENT, COMPONENTS, unused TUBES. Send list now! BARRY, 512 Broadway, New York, N. Y. 10012, 212 WALKER 5-7000.

INVENTIONS & PATENTS

FREE "Directory of 500 Corporations Seeking New Products." For information regarding developments, sale, licensing of your patented/unpatented invention. Write: RAYMOND LEE ORGANIZATION, 230-U Park Avenue, New York City 10017.

INVENTORS: protect your ideas! Free "recommended procedure". WASHINGTON INVENTORS SERVICE, 422X Washington Building., Washington, D.C. 20005

OLD TATE SALES

Post Office Box 74D

Somerville, Mass. 02143

Tel. (617) 547-4005

Circle 136 on reader service card

UNUSUAL BARGAINS BY MAIL

SHOPPING MART

A selection of products available by mail for readers of Radio Electronics. All merchandise sold on money-back guarantee. Order by No. Send check or M.O.

EXCELLENT for XMAS GIFTS!



PSYCHEDELIC LIGHTING HANDBOOK

100 information packed pages! Fully explains the latest in psychedelic lighting equipment, techniques, developments. Covers all facets of psychedelic light show production including strobes, black lights, projectors, crystals, organic slides, mirrors, color organs, polarized color, light boxes, MusicVision, etc. Shows how to "psychedelize" parties, musical groups, shows, or how to set up "electric trips" for private gatherings. 8½" X 11" looseleaf paper punched for 3 ring binder. Stock No. 9100EH \$3.00 Ppd.



ROTATING MULTI-COLORED LIGHT

Dazzling colors stream endlessly from constantly rotating light. Faceted, transparent globe has hinged drum inside with red, green, blue & yellow stars. Built best rotates drum which projects flickering star points on walls, ceilings, etc. while individual globe facets present constantly changing array of brilliant colors. 9½" star approx. 12" high on bell-shaped base. Place on table, TV, fireplace—top of Christmas tree or display. Stock No. 71,000EH \$6.00 Ppd.



3" ASTRONOMICAL TELESCOPE

See moon shots, orbits—stars, phases of Venus, planets close up. 60 to 180 power—famous Mt. Palomar reflecting type. New, improved aluminumized & overcoated 3" diameter f/10 primary mirror, ventilated cell. Equipped with 30X eyepiece and mounted 3X finder scope, hardwood tripod. FREE: "STAR CHART" "HANDBOOK OF HEAVENS" "HOW TO USE YOUR TELESCOPE" book. Stock No. 85,050EH \$29.95 Ppd. 1½" REFLECTOR TELESCOPE Stock No. 85,105EH \$94.50 FOB 6" REFLECTOR TELESCOPE Stock No. 85,086EH \$239.50 FOB

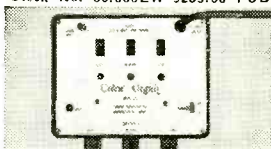

3-CHANNEL COLOR ORGAN BARGAIN

Create tremendous variety of unusual & beautiful lighting effects with this low cost top quality, 1500 Watt unit (500 W. per channel). Compares with others selling for twice the price. Has pilot light, plus individual lights. Can operate ten 150 W. "spots" or 200 Xmas lights. Uses reg. house current—attaches to audio source w/RCA-type phono plug. 5¼" x 6¾" x 2¼". 2½ lbs. Thermal setting plastic case, 6 ft. cord, Incl. compl. instruct. Stock No. 71,223EH... \$34.95 Ppd.

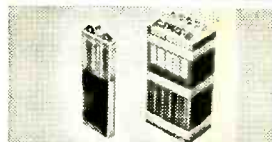

Ni-Cd BATTERY BARGAIN

Terrible value—slightly used gov't surplus. Lightweight 5 cell, 6 volt, 4 Amp-hour battery with almost unlimited life. Extremely high current output. Recharges in 1 hour when left discharged. Minimum maintenance—few drops of water per year. Rugged, shock and vibration resistant nylon case. Delivered partially charged, filled with electrolyte. 3½" x 2" x 6" 2 lb. BATTERY Stock No. 70,942EH \$15.00 Ppd. CHARGER KIT Stock No. 70,807EH \$ 8.00 Ppd. Stock No. 41,109EH. CELL \$3.95

GIANT FREE CATALOG

Edmund, 300 Edscorp Building, Barrington, New Jersey 08007

148 PAGES — 1000'S OF BARGAINS
Completely new 1970 edition, dozens of electrical and electromagnetic parts, accessories. Enormous selection of Astronomical Telescopes, Microscopes, Binoculars, Magnifiers, Magnets, Lenses, Prisms. Many war surplus. Items for hobbyists, experimenters, workshops, factory. Mail coupon for FREE catalog "FFH".

NAME.....
ADDRESS.....
CITY.....
STATE..... ZIP.....

ORDER BY STOCK NUMBER • SEND CHECK OR MONEY ORDER • MONEY-BACK GUARANTEE

EDMUND SCIENTIFIC CO. 300 EDCORP BUILDING BARRINGTON, NEW JERSEY 08007

Circle 137 on reader service card

SCHOOL DIRECTORY

GET INTO ELECTRONICS

V.T.I. training leads to success as technicians, field engineers, specialists in communications, guided missiles, computers, radar and automation. Basic & advanced courses in theory & laboratory. Electronic Engineering Technology & Electronic Technology curricula both available. Associate degree in 20 mos. B.S. also obtainable. G.I. approved. Graduates in all branches of electronics with major companies. Start Sept., Feb. Dorms. campus. High school graduate or equivalent. Catalog.

VALPARAISO TECHNICAL INSTITUTE
Dept. C, Valparaiso, Indiana 46385



distinguished graduates

hold important engineering and business administration posts throughout U.S. Professionally-oriented college with outstanding placement record. Four-quarter year permits degree in three years. Fine faculty. Modern labs. Small classes. 300-acre campus. Accredited. Approved for vets. Moderate costs. Enter Jan., March, June, Sept. For Catalog, write Adm. Director.



TRI-STATE COLLEGE
24129 College Avenue, Angola, Indiana 46703

PEP'S Dollar Sale \$1 Money Back guarantee \$1

1 Amp Silicon Rectifier
choice of package
Bullet—Miniature Glass-Metal

- 5-800V units \$1.00
- 4-1000V units \$1.00
- 3-1200V units \$1.00

3 AMP Epoxy Package

- 10-100V units \$1.00
- 5-400V units \$1.00
- 2-1000V units \$1.00

5 AMP Epoxy Package

- 8-100V units \$1.00
- 6-200V units \$1.00
- 3-800V units \$1.00

SILICON STUD MOUNT 12 AMP

- 5-100V units \$1.00
- 2-800V units \$1.00
- 1-1000V units \$1.00

SILICON STUD MOUNT 20 AMP

- 3-100V units \$1.00
- 1-1000V unit \$1.00

SILICON STUD MOUNT 40 AMP

- 3-50V units \$1.00
- 2-100V units \$1.00

SILICON STUD MOUNT 60 AMP

- 2-50V units \$1.00
- 1-1000V unit \$1.00

SILICON GLASS DIODES DO-7

- 10-100V units \$1.00

SPECIAL INTEGRATED CIRCUITS

- Dual 4 Input NAND Gate Digital \$1.50
- Quad 2 Input NAND Gate Digital \$1.50
- J K Flip Master Slave Digital \$1.75
- Linear I C Operational Amp 709C Type \$1.75

POWER TRANSISTOR
85 Watt Similar to 2N-212-1724-1208

- 1 Unit \$1.00

SCR Silicon Controlled Rectifier

TO-5 Package

- 5-40V units \$1.00
- 4-100V units \$1.00
- 3-200V units \$1.00
- 2-400V units \$1.00

7 AMP SCR

- 4-50V units \$1.00
- 3-100V units \$1.00
- 2-200V units \$1.00
- 1-800V units \$1.00

20 AMP SCR

- 2-50V units \$1.00
- 1-300V unit \$1.00

Gen Purpose PNP Germ Transistor Similar to 2N404

- 8 For \$1.00

ZENER DIODES 3 Watt

- 10 Volts
- 3 units \$1.00

ZENER DIODES 1 Watt

- 1 EA 4V-6V-8V-10V
- 4 units \$1.00

GERM GLASS DIODES DO7 GEN PURPOSE

- 20 Units \$1.00
- Replaces 1N-34 1N-60 1N-64 1N-295

Zener Diodes 250 to 400 Milliwatt

- 1 EA 2V-4V-6V-8V-10V
- 5 units \$1.00

Power Transistors

- 2N-155
- 3 units \$1.00
- 2N-176
- 2 units \$1.00

RADIATION FREE TUBE FOR COLOR TV

50,000 Volts Replaces RCA 3A-3A or Equivalent. Guaranteed for life of set or 5 years. Eliminates heat to prolong life of other tubes. \$8.99 each

NO SALES TAX WE PAY POSTAGE

PARK ELECTRONIC PRODUCTS

P. O. Box 78 N. Salem, N. H. 03073
Tel. (603) 893-0276

Circle 138 on reader service card

MARKET CENTER

INVENTIONS WANTED. Patented; Unpatented. GLOBAL MARKETING, 2420-AE 77th Ave., Oakland, Calif. 94605

GOVERNMENT SURPLUS

JEEPS Typically from \$53.00 . . . Trucks From \$78.40 . . . Boats, Typewriters, Airplanes, Multimeters, Oscilloscopes, Transceivers, Electronics Equipment, Used. 100,000 Bid Bargains Direct From Government Nationwide. Complete Sales Directory and Surplus Catalog \$1.00 (Deductible First \$10.00 Order). SURPLUS SERVICE, Box 820-REL, Holland, Michigan 49423

GENERAL

JAPANESE NEW PRODUCTS MONTHLY! \$1.00. Refundable. DEERE, 10639 Riverside, North Hollywood, Calif.

LATEST ARCTURUS SPECIALS

- Color focus rectifiers, 14,000 P.I.V. at 1 MA, 99¢ each. 6.5 KV—79¢
 - Color TV yokes 70° & 90° types. Fit almost all sets \$10.95.
 - 1700 Transistor types—39¢
 - DS-501, 2N278 power transistor types. Cat. #349, 69¢
 - HEP170, Motorola HV/Current epoxy silicon rectifiers, 2.5 amps at 1,000 PIV, 49¢
 - Fully transistorized UHF tuners. Fit most sets. Cat. #UHF567, \$4.95 each.
 - UHF tuners, 1 tube type. Fit most sets. Cat. #UHF3, \$3.95 each.
- Complete listings of electronic items at similar bargain prices are available. Write for our latest catalog. Minimum order \$5.00, plus postage.

ARCTURUS ELECTRONICS CORP.

502-22nd St., Union City, N.J. 07087
Dept. MRE
Phone: 201-864-5568

Circle 139 on reader service card

CALIBRATOR AND MORE STABILITY FOR VTVM

Many owners of vtvm's are plagued by instability and the need for a quick and accurate method of recalibrating the instrument. These problems can be solved by adding a voltage regulator tube to the unit's B-plus line and a push-button switch to connect the regulated B-plus to the input terminals so it can be used as a calibrating voltage.

Most vtvm's have a supply delivering about 130 volts so a 105-volt regulator tube such as the OA3 should be used. Connect a 1-megohm resistor (or the same value of resistance as in the dc probe) in series with the switch between the B-plus line and the vtvm's dc input. Press the switch and adjust the calibrate pot so the meter reading equals the regulated B-plus voltage.—Allan Glaser, WA4-REM

WRITE NOW FOR FREE 1970 CATALOG

McGEE RADIO COMPANY
1001 BARGAINS IN SPEAKERS—PARTS
TUBES—HIGH FIDELITY COMPONENTS
RECORD CHANGERS—TAPE RECORDERS—KITS
EVERYTHING IN ELECTRONICS
1901 McGee St., Kansas City RE, Missouri 64108

HOBBYISTS, EXPERIMENTERS, TECHNICIANS, INVENTORS, NOW YOU CAN HAVE YOUR BLACK AND WHITE TELEVISION CONVERTED TO COLOR, BY MEANS OF A NEW PATENTED CIRCUIT. COMPLETE INSTRUCTIONS AND BLUE PRINTS, WRITE, BELE ELECTRONICS CORP. 121 S.E. FIRST ST. MIAMI, FLORIDA. 33131

TREASURE & COIN DETECTOR MONEY BACK GUARANTEE

New electronic detector Penetrates deep into earth to locate gold, silver, coins, minerals. More penetrating power than ever before. Sensitive enough to locate a single coin or small nugget. Works through earth, wood, vegetation, water, rock, etc. Not a "probe" type but a fully electronic detector that is guaranteed to have at least twice the detection ability of any detector in this price range or return in 10 days for refund. Uses inexpensive 9V battery. Fully transistorized Weighs only 2 pounds. Loudspeaker signals when object is detected. Has plug-in earphone for treasure hunting in privacy. NOTHING ELSE TO BUY!

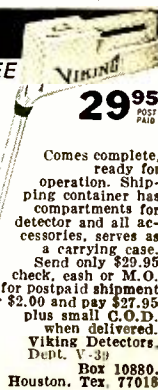

29⁹⁵
Comes complete, ready for operation. Shipping container has compartments for detector and all accessories, serves as a carrying case. Send only \$29.95 check, cash or M.O. for postpaid shipment or \$2.00 and pay \$27.95 plus small C.O.D. when delivered. Viking Detectors, Dept. V-39, Box 10880, Houston, Tex. 77018

AC VOLTMETER SPOTS TAPE RECORDER WOW

You don't have to have an expensive wow meter to check a tape recorder. You can do it with a simple ac voltmeter. Do it this way:

Using the filter/limiter in Fig. 1, record about two minutes of 60-Hz signal from the power line with the recorder's level control set to 100%. Use an ac voltmeter and measure the signal being fed from the filter net-

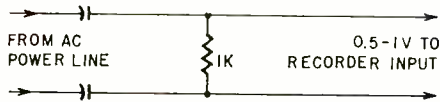

Fig. 1

work to recorder's input—0.5-volt. When you have a 2-minute recording, rewind the tape and set the recorder to playback.

Start the machine and set the volume control so the voltage across the speaker terminals is the same as the signal fed in while recording. Now, arrange the meter and R-C network as in Fig. 2. The input side of the filter is still connected to the power line and the meter and output end are con-

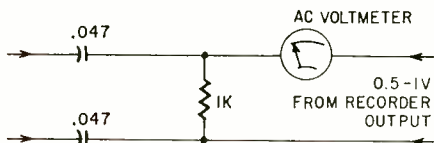

Fig. 2

nected to the recorder output terminals.

Restart the tape and watch the meter. The voltage will slowly rise to nearly twice the preset output level. The maximum voltage depends on the phase relationship between the power line and the recorded 60-Hz signal.) Now, the meter reading will slowly drop toward zero as the two voltages approach an in-phase condition. The number of dips per minute is determined by the condition of the recorder's drive system.

Normal readings for an ordinary hometype tape recorder are:

- 1 dip per minute at 7½ ips
- 3 dips per minute at 3¾ ips
- 4 dips per minute at 1¾ ips

If you get more than the desired number of dips per minute, something is wrong. Check the drive system and capstan. The meter movement must be slow. If it jumps from one end of the scale to the other, you have trouble and the entire drive system should be overhauled.—Konrad Larsson

DOUBLE BONUS

\$ 25

Radio, TV Parts. Add 25¢ for handling.

PLUS

CHOOSE ANY \$1 ITEM FREE

BOTH "GIFTS" FREE WITH \$10.00 ORDERS

709 OPERATIONAL AMPLIFIER \$179

Guaranteed! With Spec. Sheets! 3 for \$55

Actual Size			
1 AMP	PIV	Sale	PIV
MICROMINIATURE SILICON RECTIFIERS	50	5¢	600
	100	7¢	800
	200	8¢	1000
	400	10¢	

TRANSISTORS NPN & PNP **100 for \$198**

Terms: add postage. Rated: net 30, cod's 35%.
Phone Orders: Wakefield, Mass. (617) 243-3829
Retail: 211 Albion St., Wakefield, Mass.

GIANT SPRING CATALOG ON: Parts, Rectifiers, Transistors, SCRs, I.C.'s, Equipment. 10c

POLY PAKS

P.O. BOX 942 R LYNNFIELD, MASS 01940

SALE ON FAIRCHILD COUNTING DIGITAL "ICs"

No.	similar	Description	3 For \$16
<input type="checkbox"/> 958	SN7490N	Decade Counter	\$5.95
<input type="checkbox"/> 959	SN7475N	Buffer-Memory Decoder-Driver	
<input type="checkbox"/> 960	SN7441N	Decoder-Driver	

SILICON RECTIFIERS

PIV	EPOXY METAL	
	1.5A	2A
50	<input type="checkbox"/> .06	<input type="checkbox"/> .06
100	<input type="checkbox"/> .07	<input type="checkbox"/> .07
200	<input type="checkbox"/> .09	<input type="checkbox"/> .09
400	<input type="checkbox"/> .12	<input type="checkbox"/> .12
600	<input type="checkbox"/> .16	<input type="checkbox"/> .16
800	<input type="checkbox"/> .21	<input type="checkbox"/> .21
1000	<input type="checkbox"/> .32	<input type="checkbox"/> .32

1 AMP 1000 PIV 5 for \$1
 1 AMP 800 PIV 6 for \$1
 2 AMP 1000 PIV 4 for \$1

EPOXY SILICON TRANSISTORS

Type	Sale
<input type="checkbox"/> 2N2222	5 for \$1
<input type="checkbox"/> 2N2368	5 for \$1
<input type="checkbox"/> 2N2711	5 for \$1
<input type="checkbox"/> 2N2368	5 for \$1
<input type="checkbox"/> 2N3398	5 for \$1
<input type="checkbox"/> 2N3565	5 for \$1
<input type="checkbox"/> 2N3568	5 for \$1
<input type="checkbox"/> 2N3638	5 for \$1
<input type="checkbox"/> 2N3641-3	5 for \$1
<input type="checkbox"/> 2N3645	5 for \$1
<input type="checkbox"/> 2N3662	5 for \$1
<input type="checkbox"/> 2N3683	5 for \$1
<input type="checkbox"/> 2N3793	5 for \$1
<input type="checkbox"/> 2N4248	5 for \$1
<input type="checkbox"/> 2N4284-5	5 for \$1

INTEGRATED CIRCUITS

Guaranteed! With Spec. Sheets!

<input type="checkbox"/> 903	3 Input Gate NAND/Nor	\$1
<input type="checkbox"/> 904	Half Adder	
<input type="checkbox"/> 910	Dual Two Input Gate	
<input type="checkbox"/> 915	Dual 3 Input Gate NAND/Nor	
<input type="checkbox"/> 923	JK Flip Flop	
<input type="checkbox"/> 925	Dual 2 Input Gate, Expander	
<input type="checkbox"/> 927	Quad Inverter	
<input type="checkbox"/> 930	Dual 4 Input Gate NAND/Nor	
<input type="checkbox"/> 932	4 Input NAND/Nor Buffer	
<input type="checkbox"/> 933	Dual Input Gate, Expander	
<input type="checkbox"/> 944	Dual 4 Input Power Gate	3
<input type="checkbox"/> 945	Clocked Flip-Flop	
<input type="checkbox"/> 946	Quad 2 Input Gate NAND/Nor	for
<input type="checkbox"/> 952	Dual 2 Input Inverter Gate	
<input type="checkbox"/> 953	2-2-3 Input and Gate	\$2 57
<input type="checkbox"/> 954	Dual 4 Input and Gate	
<input type="checkbox"/> 955	8 Input and Gate w/2 outputs	
<input type="checkbox"/> 961	Dual 4 Input Gate w/expand	2 88
<input type="checkbox"/> 962	Triple Gate	

COUNTING DIGITAL CIRCUIT

8 Bit memory cell T0-5 case

Circle 140 on reader service card

CLASSIFIED COMMERCIAL RATE (for firms or individuals offering commercial products or services) 70¢ per word . . . minimum 10 words.
NON-COMMERCIAL RATE (for individuals who want to buy or sell personal items) 30¢ per word . . . no minimum.
 Payment must accompany all ads except those placed by accredited advertising agencies. 10% discount on 12 consecutive insertions, if paid in advance. Misleading or objectionable ads not accepted. Copy for March issue must reach us before December 8.

CLASSIFIED ADVERTISING ORDER FORM

1	2	3	4	5
6	7	8	9	10
11	12	13	14	15
16	17	18	19	20
21	22	23	24	25
26	27	28	29	30
31	32	33	34	35

No. of Words { @ .30 Non-Commercial Rates } = \$ _____
 { @ .70 Commercial Rate }

Total Enclosed \$ _____
 Insert _____ time(s)
 Starting with _____ issue

NAME _____
 ADDRESS _____
 CITY _____ STATE _____ ZIP _____
 SIGNATURE _____

Payment must accompany order unless placed through accredited advertising agency 28
 MAIL TO: RADIO-ELECTRONICS, CLASSIFIED AD DEPT., 200 PARK AVE. SOUTH, NEW YORK, N.Y. 10003

DECEMBER 1969

99

www.americanradiohistory.com

For The Experimenter!

International EX Crystal & EX Kits

OSCILLATOR / RF MIXER / RF AMPLIFIER / POWER AMPLIFIER

Type EX Crystal

Available from 3,000 KHz to 60,000 KHz. Supplied only in HC 6/U holder. Calibration is $\pm 0.02\%$ when operated in International OX circuit or its equivalent. (Specify frequency)



\$395

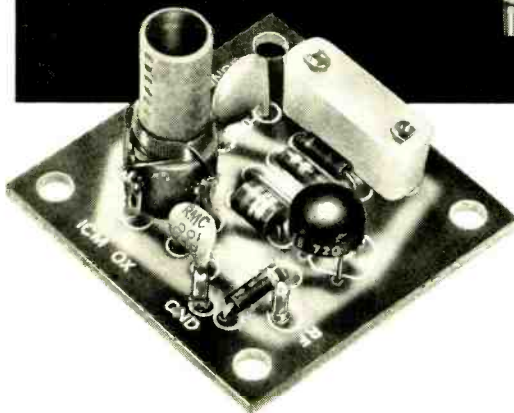

OX OSCILLATOR

Crystal controlled transistor type.
Lo Kit 3,000 to 19,999 KHz
Hi Kit 20,000 to 60,000 KHz
(Specify when ordering)

\$295

MXX-1 Transistor RF Mixer **\$3.50**
A single tuned circuit intended for signal conversion in the 3 to 170 MHz range. Harmonics of the OX oscillator are used for injection in the 60 to 170 MHz range.
Lo Kit 3 to 20 MHz Hi Kit 20 to 170 MHz
(Specify when ordering)

SAX-1 Transistor RF Amplifier **\$3.50**
A small signal amplifier to drive MXX-1 mixer. Single tuned input and link output.
Lo Kit 3 to 20 MHz
Hi Kit 20 to 170 MHz
(Specify when ordering)

PAX-1 Transistor RF Power Amplifier **\$3.75**
A single tuned output amplifier designed to follow the OX oscillator. Outputs up to 200 mw can be obtained depending on the frequency and voltage. Amplifier can be amplitude modulated for low power communication. Frequency range 3,000 to 30,000 KHz.

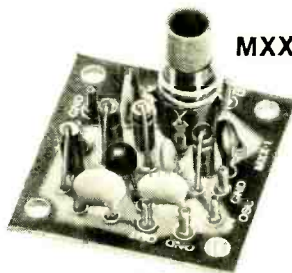

MXX-1

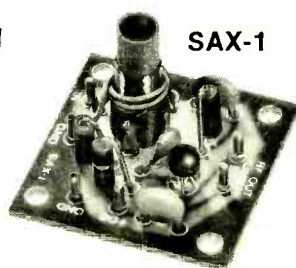

SAX-1

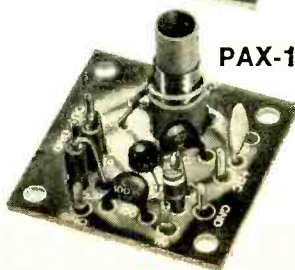

PAX-1



BAX-1

BAX-1 Broadband Amplifier **\$3.75**
General purpose unit which may be used as a tuned or untuned amplifier in RF and audio applications 20 Hz to 150 MHz. Provides 6 to 30 db gain. Ideal for SWL, Experimenter or Amateur.

Write for complete catalog.



CRYSTAL MFG. CO., INC.
10 NO. LEE • OKLA. CITY, OKLA. 73102

Circle 148 on reader service card

Perfect Christmas Gifts for the MAN WHO HAS EVERYTHING!

GE VIDEO TAPE RECORDERS

(built by Sony for General Electric)

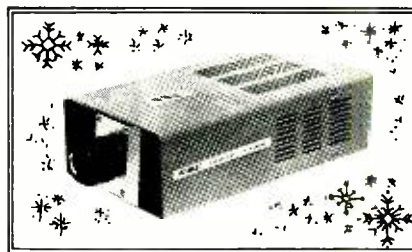

MATCHING CCTV CAMERA

This crystal controlled solid state vidicon camera is ideal for use with any video tape recorder. Can also be fed directly into a TV monitor or a home TV receiver. Better than 550 line resolution. Automatic light compensation 4000 to 1. Standard 1" F1.8 lens. Very easy to operate and unconditionally guaranteed for a full year.

only \$395.



50% OFF
REGULAR GE PRICE

ONLY

\$397⁵⁰

COMPATIBLE WITH ALL SONY 1/2" VIDEO TAPE RECORDERS INCLUDING BATTERY OPERATED PORTABLES

GBC spent half a million dollars to bring you this once-in-a-lifetime close-out price on quality video tape recorders. GE sold thousands of these units at \$795. Now, you can buy them for under \$400. You actually get a video *and* audio tape recorder for the price you'd expect to pay for a good audio tape recorder!

You can use your video tape recorder for educational TV, training, instruction, presentations, advertising, or instant home movies. Simple to operate, it tapes programs picked up by TV cameras or off-the-air, and plays them back through a standard TV monitor. Brand new, **FULLY GUARANTEED**, in original factory cartons. Order today, while they last.

VIDICONS

TOP QUALITY AT LOW, LOW PRICES.



TOP QUALITY VIDEO TAPES AT UNBELIEVABLY LOW PRICES

Only GBC could bring you an outstanding value like this. Brand new, first quality 1/2" video tape, sealed in original factory boxes. You'll recognize the brand name instantly when you receive your tape. Satisfaction guaranteed.

THESE PRICES ARE SO LOW, THAT WE CAN'T ADVERTISE THE FAMOUS NAME. BUT IT'S ONE OF THE BIG 3 VIDEO TAPE MANUFACTURERS!

1/2 HOUR VIDEO TAPE
NATIONALLY SOLD AT | GBC PRICE
\$21.95 | **\$14.97**

1 HOUR VIDEO TAPE
NATIONALLY SOLD AT | GBC PRICE
\$39.50 | **\$29.97**

The quality: brand-new Hitachi, fully guaranteed in factory-sealed cartons.

The price: (distributor cost)
Hitachi 7735-A vidicon \$34.50
Toshiba 7038-H vidicon \$29.50
Hitachi separate mesh vidicon 8507 \$74.50
Hitachi 7262—replacement for
Sony and Panasonic \$34.50

All vidicons sold in lots of 5 (10% more for lesser quantities)



WRITE FOR THE FREE GBC ENCYCLOPEDIA OF CCTV

TERMS: Check with order — FREE delivery.
COD — 25% deposit, shipped F.O.B. N.Y.C.



GBC Closed Circuit TV Corp.

74 Fifth Avenue, New York, N.Y. 10011 / Phone: (212) 989-4433

Circle 149 on reader service card

PAID PX

Why do service technicians specify RCA color picture tubes more often than any other brand?



Back in the early days of color, you had no choice. Now that you have a choice, it's still RCA by a wide preference. Why? Primarily because of experience.

And hand-in-glove with experience goes performance. Outstanding overall performance...

down through the years...with a wide variety of tube sizes.

Put them together and they add up to confidence...for the service technician who installs the tube...for the set owner who has to pay the bill.

RCA puts its reputation on the line with every picture tube it makes. Whether it's the RCA HI-LITE built to OEM specs all the way...or a quality rebuilt RCA Colorama...you can rely on RCA picture tubes to protect your hard earned service reputation. They're designed to protect the biggest reputation in the COLOR TV industry.

RCA Electronic Components, Harrison, N.J.

RCA